

8142

DIGITAL INDICATOR

Technical Manual

TM008142 I06

Declaration of conformity
Konformitätserklärung
Déclaration de conformité
Declaración de Conformidad
Verklaring de overeenstemming
Dichiarazione di conformità

We/Wir/Nous/WIJ/Noi: Mettler-Toledo, Inc.
1150 Dearborn Drive
Worthington, Ohio 43085
USA

declare under our sole responsibility that the product,
erklären, in alleiniger Verantwortung, daß dieses Produkt,
déclarons sous notre seule responsabilité que le produit,
declaramos, bajo nuestra sola responsabilidad, que el producto,
verklaren onder onze verantwoordelijkheid, dat het product,
dichiariamo sotto nostra unica responsabilità, che il prodotto,

Model/Type: 8142-2009

to which this declaration relates is in conformity with the following standard(s) or other normative document(s).
auf das sich diese Erklärung bezieht, mitder/den folgenden Norm(en) oder Richtlinie(n) übereinstimmt.
Auquel se réfère cette déclaration est conforme à la (aux) norme(s) ou au(x) document(s) normatif(s).
Al que se refiere esta declaración es conforme a la(s) norma(s) u otro(s) documento(s) normativo(s).
Waarnaar deze verklaring verwijst, aan de volende norm(en) of richtlijn(en) beantwoordt.
A cui si riferisce questa dichiarazione è conforme alla/e sequente/i norma/e o documento/i normativo/i.

CE Conformity / CE-Konformität / Conformité CE
90/384/EU Nonautomatic Balances and Scales / Nichteselbsttätige Waagen / Balances à Fonctionnement non automatique
Article 1.2.b.
89/336/EU EMC Directive / EMU-Richtlinie / Directive concernant la CEM*
EN55022, A 01.04.87 Emissions / Funkstörungen
EN50081-1 Immunity
*When installed per manufacturers specifications detailed in the Technical Manual

Other Directives and Standards / Andere Richtlinien und Normen / Autres documents
corresponding to local requirements / entsprechend lokalen Anforderungen / correspondant aux exigences locales
UL 1950 el. Safety / el. Sicherheit / sécurité el. (if UL mark is applied)
CSA C22.2 No. 950-M89 el. Safety / el. Sicherheit / sécurité el. (If CUL mark is applied)
FCC, Part 15, class A Emissions / Funkstörungen (If CUL mark is applied)

Darrell Flocken, Manager - Weights & Measures
Office of Weights and Measures
Worthington, Ohio USA
October, 1995

according to EN45014

©Mettler-Toledo, Inc. 1996

No part of this manual may be reproduced or transmitted in any form or by any means, electronic or mechanical, including photocopying and recording, for any purpose without the express written permission of Mettler-Toledo, Inc.

U.S. Government Restricted Rights: This documentation is furnished with Restricted Rights.

INTRODUCTION

This publication is provided solely as a guide for individuals who have received Technical Training in servicing the METTLER TOLEDO product.

Information regarding METTLER TOLEDO Technical Training may be obtained by writing to:

METTLER TOLEDO
1150 Dearborn Drive
Worthington, Ohio 43085-6712
(614) 438-4400

WARNING!

This equipment generates, uses, and can radiate radio frequency energy and if not installed and used properly, i.e., in accordance with the instructions manual, may cause harmful interference to radio communications. It has been tested and found to comply with the limits for a Class A computing device pursuant to Subpart J of Part 15 of FCC Rules, which are designed to provide reasonable protection against such interference when operated in a commercial environment. Operation of this equipment in a residential area is likely to cause interference which case the user at his own expense will be required to take whatever measures may be required to correct the interference.

**METTLER TOLEDO RESERVES THE RIGHT TO MAKE REFINEMENTS OR
CHANGES WITHOUT NOTICE.**

PRECAUTIONS

READ this manual
BEFORE operating or
servicing this equipment.

FOLLOW these
instructions carefully.



SAVE this manual for
future reference.



DO NOT allow untrained
personnel to operate, clean,
inspect, maintain, service,
or tamper with this
equipment.

ALWAYS DISCONNECT
this equipment from the
power source before
cleaning or performing
maintenance.

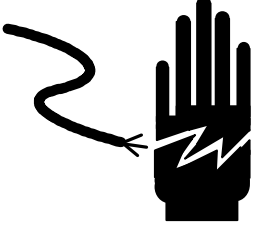
CALL METTLER
TOLEDO for parts,
information, and service.

	 WARNING
	ONLY PERMIT QUALIFIED PERSONNEL TO SERVICE THIS EQUIPMENT. EXERCISE CARE WHEN MAKING CHECKS, TESTS AND ADJUSTMENTS THAT MUST BE MADE WITH POWER ON. FAILING TO OBSERVE THESE PRECAUTIONS CAN RESULT IN BODILY HARM.

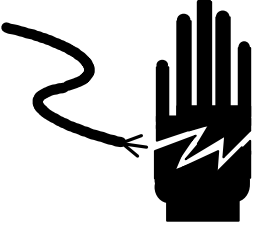
	 WARNING
	FOR CONTINUED PROTECTION AGAINST SHOCK HAZARD CONNECT TO PROPERLY GROUNDED OUTLET ONLY. DO NOT REMOVE THE GROUND PRONG.

	 WARNING
	DISCONNECT ALL POWER TO THIS UNIT BEFORE REMOVING THE FUSE OR SERVICING.

 CAUTION
BEFORE CONNECTING/DISCONNECTING ANY INTERNAL ELECTRONIC COMPONENTS OR INTERCONNECTING WIRING BETWEEN ELECTRONIC EQUIPMENT ALWAYS REMOVE POWER AND WAIT AT LEAST THIRTY (30) SECONDS BEFORE ANY CONNECTIONS OR DISCONNECTIONS ARE MADE. FAILURE TO OBSERVE THESE PRECAUTIONS COULD RESULT IN DAMAGE TO OR DESTRUCTION OF THE EQUIPMENT OR BODILY HARM.

 CAUTION
OBSERVE PRECAUTIONS FOR HANDLING ELECTROSTATIC SENSITIVE DEVICES.

Contents

1. GENERAL DESCRIPTION	1
1.1. Standard Features All Versions	1
1.2. Dual Display Features	2
1.3. Dual Display Advanced Features	3
2. SYSTEM DESCRIPTION	4
2.1. Major Components	4
2.2. Factory Number Configuration Guide	4
3. SPECIFICATIONS	5
3.1. Environment	5
3.2. Power Requirements	5
3.3. Standards Compliance	6
3.4. Radio Frequency Interference	6
3.5. Appearance and Dimensions	6
3.6. Display	7
3.7. Data Interface	8
3.7.1. JN Printer Port	8
3.7.2. JW Setpoint Port (Dual Display Advanced Versions Only)	8
3.7.3. JY Host Interface Option (Dual Display Advanced Versions Only)	9
4. INSTALLATION INSTRUCTIONS	10
4.1. PRELIMINARY INSPECTION	10
4.1.1. Opening the Desk Enclosure	10
4.1.2. Opening the Wall Enclosure	10
4.1.3. Opening the Rack Enclosure	10
4.2. AC Power Voltage Selection	10
4.2.1. Desk and Rack Enclosure Voltage Selection	11
4.2.2. Wall Enclosure Voltage Selection	11
4.3. Preliminary Calculations	12
4.3.1. Microvolts per Increment Calculation	12
4.3.2. Total Increments Calculation	12
4.3.3. Microvolt Build Table	12
4.4. Setpoint Installation Considerations	14
4.4.1. RFI Precautions	14
4.4.2. Power Precautions	14
4.4.3. Inductive Load Precautions	15

4.4.4. Static Discharge Precautions	15
4.5. Programming and Calibration	15
4.5.1. Keyboard Functions During Setup	16
4.5.3. Model 8142 Setup Quick Reference Chart	18
4.5.4. Setup Step Descriptions	21
4.5.5. Calibration Procedure	44
4.5.6. Span Adjust	47
4.6. Sealing The NEMA 4X Wall Mount Enclosure	48
5. OPERATING INSTRUCTIONS	49
5.1. DISPLAY(S) DESCRIPTION	49
5.2. DISPLAY CURSORS	50
5.3. KEYBOARD DESCRIPTIONS	51
5.4. SETPOINT DATA ENTRY	53
5.4.1. Data Entry for 4 Setpoint Mode	53
5.4.2. Data Entry for 2 Setpoint Mode	54
5.5. POWER-UP SEQUENCE	55
6. HARDWARE SETUP	56
6.1. PCB CONNECTORS AND JUMPERS	56
6.1.1. Single Display/Main PCB	56
6.1.2. Dual And Dual Display Advanced PCB	57
6.1.3. Display PCB (Rack Versions Only)	57
6.1.4. Optional BCD/Analog PCB (Dual Display Advanced Rack and Wall Enclosures Only)	58
6.2. ENCLOSURE CONNECTOR LOCATIONS	59
6.2.1. Desk Enclosure (Rear View)	59
6.2.2. Wall Enclosure (Bottom View)	59
6.2.3. Rack Enclosure (Rear View)	60
6.3. Load Cell Interconnect	61
6.3.1. J1 Connector Load Cell Cable Termination for Desk and Rack Enclosure Versions	61
6.3.2. Wall Enclosure	64
6.3.3. Junction Box Connections	65
6.4. JN Printer Port	68
6.4.1. JN Port Printer Interconnect	69
6.4.2. Demand Mode Output Format	71
6.4.3. JN Port Toledo® Continuous Format	72
6.4.4. JN Port Remote Input Commands	74
6.5. JW SETPOINT PORT	74
6.5.1. JW Port Connector Pinout	75
6.5.2. Handshaking Signal Descriptions	75
6.5.3. 20 mA Remote Pushbutton Inputs	76
6.5.4. JW Port TTL Setpoint Operation	77
6.5.5. JW Port Continuous Format Output	78
6.5.6. JW Port ASCII Remote Commands	79

6.6. JY Host Port	79
6.6.1. JY Host Port Interconnect	80
6.6.2. Handshaking Signal Descriptions	80
6.6.3. JY Port Interface Protocol	80
6.6.4. JY Host Port Function Codes	82
6.7. Optional BCD/Analog K.O.P.	93
6.7.1. J2 BCD/Analog Interconnect	93
6.7.2. TTL Status Outputs	95
6.7.3. TTL Control Inputs	95
6.7.4. Analog Output	95
7. MAINTENANCE	96
7.1. Troubleshooting	96
7.2. Error Codes	97
7.2.1. Operational Error Codes	97
7.2.2. Calibration Error Codes	98
7.3. Power Supply Voltage Checks	98
7.3.1. Main PCB Voltage Checks	99
7.3.2. Dual Display PCB DC Voltage Checks	101
7.3.3. AC Transformer Voltages	103
8. SPARE PARTS AND ACCESSORIES	104
8.1. Spare Parts	104
8.2. Cables and Mating Connectors.....	105
8.3. Optional Kits Of Parts (KOP).....	106
9. INDEX	107
10. INTERCONNECT DRAWING	109
10.1. Single Display Versions	109
10.2. Dual Display and Dual Display Advanced Versions	110

11. PARTS CATALOG	112
11.1 DESK UNIT FORM COVER AND KEYBOARD	112
11.2 DESK UNIT REAR COVER.....	113
11.3 DESK UNIT INSIDE FRONT COVER	114
11.4 DESK UNIT PCB'S & MISCELLANEOUS HARDWARE	115
11.5 DESK UNIT POWER SUPPLY	116
11.6 WALL UNIT ENCLOSURE DOOR & KEYBOARD	117
11.7 WALL UNIT INSIDE ENCLOSURE DOOR.....	118
11.8 WALL UNIT SINGLE DISPLAY PCB'S & MISCELLANEOUS HARDWARE	119
11.9 WALL UNIT DUAL & DUAL ADVANCED PCB'S & MISC. HARDWARE.....	120
11.10 WALL UNIT POWER SUPPLY.....	121
11.11 RACK UNIT COVER & FRONT PANEL	122
11.12 RACK UNIT CHASSIS & TOP COVER	123
11.13 RACK UNIT SINGLE DISPLAY PCB'S & MISC. HARDWARE.....	124
11.14 RACK UNIT DUAL & DUAL ADVANCED PCB'S & MISC. HARDWARE.....	125
11.15 RACK UNIT DUAL & DUAL ADVANCED PCB'S & MISC. HARDWARE.....	126
11.16 RACK UNIT POWER SUPPLY.....	127
12. INTERCONNECTING CABLES	128
13. MATING CONNECTORS	129
14. KITS OF PARTS	130

1. GENERAL DESCRIPTION

The Model 8142 is an industrial digital indicator intended for use with **ANALOG LOADCELLS ONLY**. The 8142 is available in 3 versions: single display, dual display, and dual display-advanced.

1.1. Standard Features All Versions

The single display version includes the following features:

- Operator input is via a tactile feedback, 20 position membrane keyboard.
- Display of gross, tare or net weight on a 6 digit, seven segment, blue-green, fluorescent display with 0.5" high digits.
- All setup functions and calibration sequences are programmable through the keyboard. Setup access is by means of internal hardware jumper.
- Span adjust and zero adjust permit fine adjustment without total recalibration.
- Units switching between pounds (lb) or kilograms (kg).
- Keyboard or pushbutton tare entry.
- +12.5 VDC or +5 VDC excitation voltage for up to six 350 \hat{e} load cells or twelve 725 \hat{e} load cells is supplied. Total Scale input resistance should not drop below 59 \hat{e} .
- Jumper selectable 2 mV/V or 3 mV/V load cell input.
- Initial dead load offset of up to 27 mV for 2 mV/V load cells and up to 40.5 mV for 3 mV/V load cells.
- Allowable span range of 3 mV minimum to 30 mV maximum for 2mV/V load cells, 4.5 mV minimum to 45 mV maximum for 3 mV/V load cells.
- The resolution of the 8142 or total number of displayed increments is selectable from a minimum of 600 increments to a maximum of 50,000 increments.
- The displayed increment size is selectable from a minimum of 0.00001 to maximum of 100.
- Motion detection is selectable from a minimum of ± 0.5 to a maximum of ± 3 increments over a selectable period ranging from 1 to 31 A/D updates.
- A selectable digital filter is available to provide a more stable weight reading in the presence of vibration.
- Pushbutton zero. Selectable to $\pm 2\%$ or $\pm 20\%$ of programmed scale capacity.
- Auto zero maintenance (AZM) compensates for small changes in zero over selectable ranges of ± 0.5 increments to ± 3 increments.

- Over capacity blanking can be programmable independently of the scale capacity selected in calibration.
- The JN port provides a flexible, bi-directional, serial interface with RS-232C, 20 ma current loop and RS-422 (two wire, half duplex) compatible interfaces.
- The JN port accepts single character ASCII commands for remote print, tare, clear and zero functions.
- The JN port demand format outputs single or multi-line gross, tare and net weight or displayed weight. The demand format is compatible with Toledo Scale printers, Models 307, 8806, 8843, 8855 and 8860. The demand format can also be used for static weight computer interfacing.
- Double width printing of displayed weight is selectable if supported by the printer used.
- A net sign correction mode is available in the demand format output mode for "Truck Dump" applications.
- The demand mode output supplies a printer interlock to prevent multiple prints of the same weight that are 10 displayed increments above zero.
- From 0 to 99 linefeeds are added at the end of a demand format output to facilitate ticket printing with continuous forms.
- The JN port can also be configured for Toledo® continuous format, Masstron® continuous format, and Toledo® short form continuous data output for compatibility with Toledo Scale Scoreboard Models 8614 and 8616, Toledo Scale Remote Display Model 8623 and for real time computer interfacing applications.

1.2. Dual Display Features

The dual display versions include all the features of the single display versions plus the following features:

- Display of gross or net weight in a 6 digit, seven segment, blue-green, fluorescent primary display with 0.5" high digits. Tare weight, time, date, I.D. or consecutive number can be displayed by the dual display 8142 in a 6 digit, seven segment, blue-green, fluorescent auxiliary display with 0.5" high digits.
- Keyboard entry and display of time, date, I.D., and consecutive number. Data is retained during power loss.
- Time, date, I.D., and consecutive numbering information can be output through the JN port.
- All setup and calibration data can be printed out the JN port.
- Linearization by means of a three point calibration procedure is available if necessary.
- Keyboard entry of "short cut" calibration factors.
- Analog and digital verification.
- The time of day clock can be adjusted to provide a more accurate clock.

1.3. Dual Display Advanced Features

The dual display advanced versions include all the features of the dual display versions plus the following features:

- A bi-directional serial port (JW) provides RS-232C continuous format data output with TTL setpoint cutoff status bits for connection to external cutoff circuitry.
- The JW port can accept remote ASCII entry of tare weight, I.D. or both.
- The JW port can accept single character ASCII commands for remote print, tare, clear and zero functions.
- The setpoint outputs can be configured as two, dual speed setpoints cutoffs with programmable dribble, preact and tolerance. The setpoints can also be configured as four, single speed setpoint cutoffs.
- Setpoint data can be displayed on the auxiliary display.
- Setpoint values can be hand entered on the keyboard or downloaded from a remote computer by the optional JY host port.
- The optional host interface port (JY) provides a master/satellite network protocol with an RS-232C interface for single scale applications and an RS-485 multidrop interface (two wire, half duplex) for up to eight, 8142 indicators.

2. SYSTEM DESCRIPTION

The 8142 provides excitation voltage for analog, full bridge strain gauge load cells. The load cell's output is a very small analog signal of from 0 to a few millivolts as the weight on the scale varies from zero to capacity. The 8142 conditions and amplifies this signal voltage to a 0 to 10 VDC range. The amplified voltage is then filtered and converted to a digital value by means of a triple slope integration A/D converter. The A/D converter supplies 10 internal counts for every displayed increment. The update rate is from 4 to 10 conversions per second. The update rate is slowed when the number of displayed increments exceeds 10,000 and is also slowed when continuous format data output is used.

2.1. Major Components

- 1 - Transformer: Steps down the AC power to lower voltages for use by the PCB's.
- 2 - Main PCB: Contains the DC power supplies, control logic, analog section, program jumpers, JN printer port and single fluorescent display (display not present on dual display or rack mount versions).
- 3 - Dual Display PCB: Present on dual display and dual display-advanced versions only, contains control logic, program jumpers, JW and JY port on dual-display advanced only and two fluorescent displays (displays not present on rack mount versions).
- 4 - Display PCB: (rack mount versions only) - contains 1 or 2 fluorescent displays.
- 5 - Keyboard: Provides an operator interface for functions such as tare, print, clear, test, units selection and calibration/setup.

2.2. Factory Number Configuration Guide

Factory Number	AA{ 8142- 0007	
		3 3333
		3 3333
Model Number (8142)	AAU	3333
		3333
Digit #1: Enclosure Type	AAU	333
0 = Desk		333
1 = Wall		333
2 = Rack		333
		333
Digit #2: Intrinsic Safe	AAU	33
0 = Standard		33
1 = Desk and Wall Mount Intrinsic Safe Version		33
2 = Rack Mount Intrinsic Safe Version		33
		33
Digit #3: Lens and Keyboard	AAU	3
0 = English Lens/Keyboard		3
1 = Export (No lens/keyboard)		3
2 = Export (English lens/keyboard)		3
		3
Digit #4: Display Version	AAU	
7 = Single Display		
8 = Dual Display		
9 = Dual Display Advanced		

3. SPECIFICATIONS

3.1. Environment

The 8142 operates from -10 to +40 °C (+14 to +104 °F) at 0 to 95% relative humidity noncondensing. Zero temperature coefficient is 0.1 µV/°C maximum. Span temperature coefficient is 6 PPM/°C maximum.

The 8142 desk and rack enclosure versions must not be used in wet or extremely dusty environments.

The 8142 stainless steel enclosure versions meet NEMA 4X hosedown requirements.

 WARNING
<p style="text-align: center;">The standard 8142 is not intrinsically safe! Special versions of the 8142 with reduced load cell excitation voltage are available for use with Hazardous Area Protection intrinsic safe modules in hazardous areas. For more details contact your local Authorized Toledo Scale Representative.</p>

3.2. Power Requirements

The 8142 can operate (by selection) at 120 VAC, 220 VAC or 240 VAC (+10% -15%) at a line frequency from 49 to 61.5 Hz. Maximum power consumption is 25 watts.

 CAUTION
<p style="text-align: center;">ALL UNITS ARE SHIPPED FOR 120 VAC OPERATION. REFER TO SECTION 4.2 FOR ALTERNATE VOLTAGE SELECTION.</p>

The 8142 requires clean AC power with a true earth ground for reliable operation. The power line for the 8142 must not be shared with equipment that generates line noise (such as motors, relays, heaters, etc.). If adverse power conditions exists, a power line conditioner may be required.

The 8142 meets the NIST H-44 and Canadian Gazette, Part 1 line voltage variation specifications.

Line Voltage Variation Specification	AC Line Voltage			Line Frequency in Hz		
	Min	Nom	Max	Min	Nom	Max
NIST H-44	100	120	130	59.5	60	60.5
Canadian	108	120	132	58.8	60	61.2

3.3. Standards Compliance

The Model 8142 is UL listed to meet specifications 114, Office Appliances and Equipment.

The Model 8142 is C.S.A. certified to meet standard C22.2 No. 143-1975, Office Machines.

The Model 8142 meets or exceeds FCC docket 80-284 for radiated and conducted emissions.

The Model 8142 has received NTEP (National Type Evaluation Program) Certificate of Conformance number 87-106 and may be used in legal-for-trade applications as a class III or IIIL device.

3.4. Radio Frequency Interference

In environments where any RFI radiation exists, the stainless steel wall mount enclosure or the desk mount enclosure should be used. These models have been designed to greatly reduce susceptibility to Radio Frequency Interference. In areas where high levels of RFI are known to exist, an RFI protection kit of parts (K.O.P.) 0917-0110 for desk enclosure or 0917-0182 for wall mount enclosure must be installed. These K.O.P.'s supply an RFI filtered load cell harness and an RFI filtered printer adapter.

With the addition of the optional RFI protection K.O.P. the desk and wall mount enclosures meet USA and Canadian requirements for RFI susceptibility specifications as listed with a maximum change of one displayed increment.

Specification	Frequencies in MHz	Field Strength
USA	27, 169 and 464	3 volts/meter
Canadian	27 and 464	4 watts at 2 meters

Table 3-1 RFI Susceptibility with RFI Option Installed

3.5. Appearance and Dimensions

The desk mount version is a charcoal black painted, two piece, die cast aluminum enclosure. The desk enclosure is 8.4" (213 mm) high, 12.6" (320 mm) wide by 6.5" (165 mm) deep. The desk enclosure version weighs 15 lb (6.8 kg).

The wall version is an unpainted, brushed stainless steel enclosure. The wall mount enclosure is 11.3" (287 mm) high, 13.9" (353 mm) wide by 5.5" (140 mm) deep. The wall mount enclosure can be wall or column mounted. The wall mount version weighs 19 lb (8.6 kg).

The rack version is a charcoal black painted, sheet metal enclosure with a black painted, die cast aluminum display bezel. The rack mount enclosure is 3.5" (89 mm) high, 17" (432 mm) wide by 9.3" (236 mm) deep. The rack enclosure version weighs 15.4 lb (7 kg).

The rack enclosure is designed to be mounted in a panel with the optional panel mount KOP (0917-0005). Refer to Figure 3-1 for mounting dimensions.

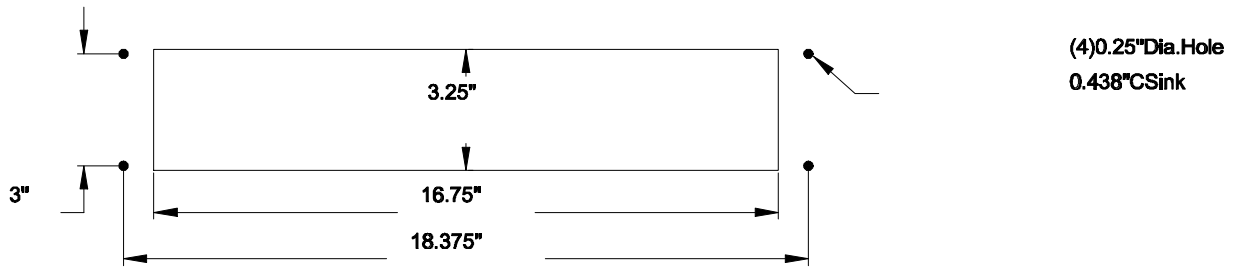

Figure 3-1 Panel Mounting Detail For Rack Mount Enclosure

3.6. Display

All versions of the 8142 have a gray display lens with 1 or 2, 6 digit, blue-green, seven segment, vacuum fluorescent display.

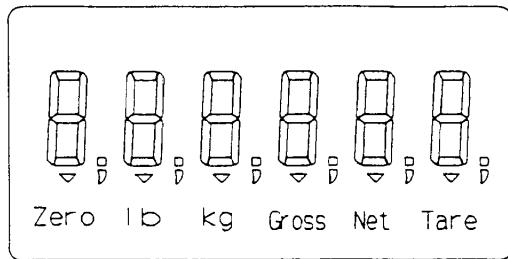

Figure 3-2 Single Display

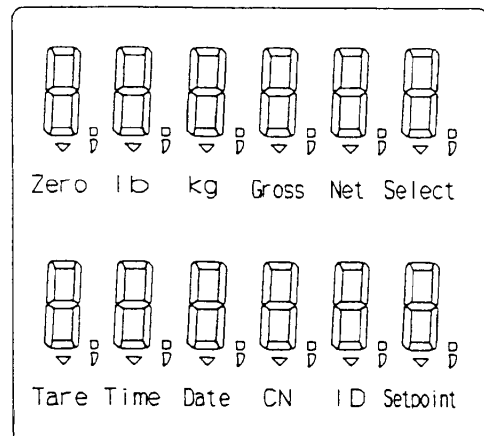

Figure 3-3 Dual Display Advanced

3.6.1. Single Display Version

Includes the primary weight display with cursors to indicate zero, lb, kg, gross, net and tare.

3.6.2. Dual Display Version

Includes the primary weight display with cursors for Zero, lb, kg, Gross, and Net. An auxiliary data display is provided with cursors for Tare, Time, Date, CN, and ID.

3.6.3. Dual display Advanced Version

Includes the primary weight display with cursors for Zero, lb, kg, Gross, Net and Select. An auxiliary data display is provided with cursors for Tare, Time, Date, CN, ID, and Setpoint.

3.7. Data Interface

3.7.1. JN Printer Port

All versions of the 8142 provide one bi-directional serial port with RS-232C, RS-422 (two wire, half duplex) and 20 mA current loop interfaces. The JN port provides two modes of operation, demand and continuous.

3.7.1.1. Demand Output

When a print command is received, either by means of the PRINT key, a remote print signal, remote ASCII input or Autoprint function, the 8142 will output a message as formatted by setup. The data output is available from 300 to 9600 baud and can include expanded print format as well as an optional checksum character.

Demand output is disabled when the 8142 is blanked under zero or over capacity, in a "motion" condition or if displaying expanded weight.

3.7.1.2. Continuous Output

Continuous format output is transmitted after every display update, from 4 to 10 times per second. Three different continuous formats are available: Toledo® Continuous, Masstron® Continuous and Toledo® Short Form Continuous. The continuous output is available from 1200 to 9600 baud.

The 8142 can also be programmed to output one Toledo® Continuous format message every time an ASCII <ENQ> character is received by the JN Port.

3.7.1.3. Remote ASCII Control Input

The JN port can accept single ASCII character commands to perform remote print, tare, clear and zero functions.

3.7.2. JW Setpoint Port (Dual Display Advanced Versions Only)

The JW port provides an RS-232C Toledo® Continuous format output transmitted every display update. The continuous output is identical to the JN port Toledo® Continuous format with the addition of setpoint status data. The data output is available from 1200 to 9600 baud.

3.7.2.1. JW Port ASCII Input

The JW port can be programmed to accept Remote ASCII Input in one of the two modes described next.

3.7.2.1.1. JW Port Remote Command Input

The JW port can accept single ASCII character commands to perform remote print, tare, clear and zero functions.

3.7.2.1.2. JW Port Remote Tare/ID Input

The 8142 can accept up to 6 digits of tare data and/or to 6 digits of numeric ID data from a remote terminal or bar code reader in place of the remote single ASCII control input.

3.7.3. JY Host Interface Option (Dual Display Advanced Versions Only)

The optional JY host interface K.O.P. provides the dual display advanced versions a master/satellite network protocol for interfacing with remote computers.

The JY port provides an RS-232C interface for single scale applications and a two wire, half duplex, RS-485 multidrop interface allows the connection of up to eight 8142's to a single host computer serial port.

The JY port allows the remote host computer to read displayed, gross, tare and net weight from the 8142. All setpoint data can be uploaded and downloaded to and from the JY port. Setup bytes, status bytes and control bytes allow the remote host to monitor and control the operation of the 8142.

4. INSTALLATION INSTRUCTIONS

4.1. PRELIMINARY INSPECTION

Inspect the shipping container and scale for loose or damaged parts. If any damage is found, immediately notify the freight carrier.

Open the enclosure and verify that all internal harnesses are securely fastened. Install any optional K.O.P. at this time.

Terminate the load cell cable. Refer to Section 6.3. for interconnect data and cable installation instructions.

Verify the AC power selection as described in section 4.2. and connect the 8142 to the appropriate power source as described in section 3.2.

4.1.1. Opening the Desk Enclosure

The desk enclosure is opened by removing the four screws from the corners of the rear cover. Be careful not to damage the keyboard when removing the front cover. DO NOT over tighten the cover screws when reinstalling them.

4.1.2. Opening the Wall Enclosure

The wall enclosure is opened by flipping the wing type handle of each fastener up and turning them 1800 counter clockwise. Loosen the hinge fasteners on the left side last (be sure to loosen them both at the same time to prevent jamming).

4.1.3. Opening the Rack Enclosure

The rack enclosure is opened by loosening the 2 front panel screws and sliding the chassis out of the outer case. Remove the 3 inner cover retaining screws and the inner cover. Use caution reinstalling the front panel screws to prevent cross threading.

4.2. AC Power Voltage Selection

All U.S. versions are shipped configured for 120 VAC operation. All general export versions are shipped configured for 220 VAC operation.

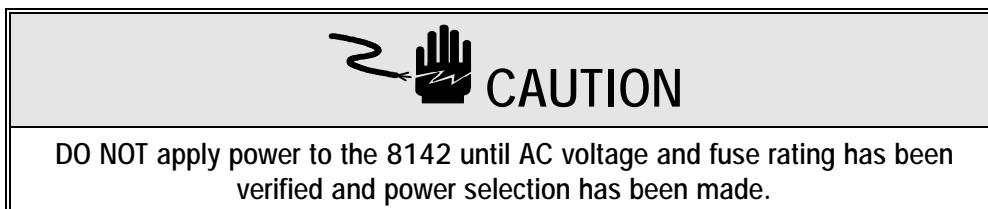



WARNING

Disconnect all power to the 8142 before making AC voltage selection.

4.2.1. Desk and Rack Enclosure Voltage Selection

Remove the AC power cord from the AC filter assembly located on the right side of the Desk enclosure or on the rear of the Rack enclosure. Refer to Figure 4-1.

Slide the clear plastic fuse cover to the side, exposing the fuse. Pull the handle labeled FUSE PULL and remove the fuse.

With the fuse removed, use a small screwdriver or similar object and gently pry the voltage selection card straight out of the AC filter assembly. A small hole in the card is provided to assist removal.

Insert the voltage selection card so that the desired voltage marking is readable and located on the left side of the card.

Install the correct size fuse in the fuse holder. The 100 VAC and 120 VAC voltage selections require a 0.5 A slo-blo fuse. The 220 VAC and 240 VAC voltage selections require a 0.25 A slow blow fuse.

Slide the fuse cover back into place and connect the AC power cord to the AC filter assembly.

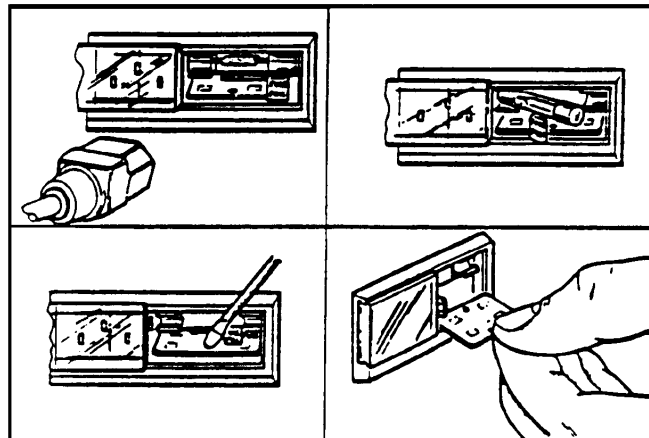

Figure 4-1 Desk and Rack AC Voltage Selection

4.2.2. Wall Enclosure Voltage Selection

All wall enclosure U.S. versions are shipped configured for 120 VAC operation with the 120 VAC voltage selection harness (133114 00A) and 0.5 A fuse installed. The 220 VAC voltage selection harness (*133115 00A) and 0.25 A fuse required for 220 VAC operation are packed loose in the box.

All wall enclosure general export versions are shipped configured for 220 VAC operation with the 220 VAC voltage selection harness (*133115 00A) and 0.25 A fuse installed. The 240 VAC voltage

selection harness (*133116 00A) required for 240 VAC operation is packed loose in the box. 220 VAC and 240 VAC operation use the same 0.25 A fuse.

4.3. Preliminary Calculations

If the scale base used is a standard Toledo® Model and a standard build is desired then proceed with the installation of the scale.

If a nonstandard build is desired or if the scale base is a conversion of an existing mechanical scale then the microvolts per increment must be calculated to verify that the scale build desired (increment size and total number of increments) is attainable with the scale base to be used.

4.3.1. Microvolts per Increment Calculation

Use the following formula to calculate microvolts per increment.

$$\mu\text{V per Increment} = \frac{I * V * O * 1000}{C * R}$$

I - Increment size desired: Increment size, scale capacity and load cell capacity must all be measured in the same weight units, lb or kg. If units are different then multiply kg units by 0.45359 to convert to lb units for the purposes of this calculation.

V - Excitation Voltage: Normal 8142 excitation voltage is 12.5 VDC. HAP (Hazardous Area Protection) versions supply 5 VDC excitation voltage.

O - Load cell output rating in mV/V (millivolts per volt of excitation): The load cell output is normally marked on the load cell. Toledo load cells are typically 2 mV/V. Other types can range from 1 mV/V to 4.5 mV/V.

C - Load cell capacity.

R - Total number of load cells or total lever ratio (If mechanical scale conversion).

4.3.2. Total Increments Calculation

The total number of increments is calculated by dividing the desired scale capacity by the increment size.

4.3.3. Microvolt Build Table

Use Table 4-1 to determine if the μV per increment calculated in step 4.3.1. is within the range allowed for the total number of increments calculated in step 4.3.2.

The 8142 provides Jumper W7 on the Main PCB to allow operation with 2 mV/V or 3 mV/V load cells. The 2 mV/V and 3 mV/V columns under the Maximum μV per Increment heading in Table 4-1, apply depending on Jumper W7 selection.

Total Number of Increments	Minimum μV per Increment	Maximum μV per Increment	
		2 mV/V	3 mV/V
600	5.0	43.3	63.3
1,000	3.0	26.0	38.0
1,200	2.5	21.7	31.7
1,500	2.0	17.3	25.3
2,000	1.5	13.0	19.0
2,500	1.2	10.4	15.2
3,000	1.0	8.7	12.7
4,000	0.75	6.5	9.5
5,000	0.6	5.2	7.6
6,000	0.5	4.4	6.4
8,000	0.375	3.3	4.8
10,000	0.3	2.6	3.8
12,000	0.3	2.2	3.2
15,000	0.3	1.7	2.5
16,000	0.3	1.6	2.4
20,000	0.3	1.3	1.9
25,000	0.3	1.0	1.5
30,000	0.3	0.87	1.3
32,000	0.3	0.81	1.2
35,000	0.3	0.74	1.1
40,000	0.3	0.65	0.95
45,000	0.3	0.58	0.84
48,000	0.3	0.54	0.80
50,000	0.3	0.52	0.76

Table 4-1: Micro Volt Build

Notes:

- 1 - The 8142 should never be programmed to less than 1.0 μV per increment when used with single load cell applications and never less than 0.3 μV per increment when used with multiple load cell applications.
- 2 - The 8142 **CANNOT** be calibrated for builds that exceed the maximum μV per increment listed in Table 4-1.

Refer to the following example of μV per Increment calculation for a Model 2157 floor scale installation.

Scale Capacity 5000 lb
Increment Size 0.5 lb
Load Cell Capacity 2000 lb
Number of Cells 4
Cell Output 2 mV/V
Excitation Voltage 12.5 VDC

First use the formula from step 4.3.1. to calculate the μV per increment.

$$\frac{0.5 \text{ lb} * 12.5 \text{ VDC} * 2 \text{ mV/V} * 1000}{2000 \text{ lb} * 4 \text{ load cells}} = 1.56 \mu\text{V per increment}$$

Next, divide the scale capacity by the increment size to determine the total number of increments.

$$\frac{5000 \text{ lb}}{0.5 \text{ lb}} = 10,000 \text{ Increments}$$

Check Table 4-1 to see that a microvolt build of 1.56 μV per increment build is within the acceptable range for 10,000 increments. It does, so this is an acceptable build.

4.4. Setpoint Installation Considerations

 WARNING
WHEN THIS EQUIPMENT IS INCLUDED AS A COMPONENT PART OF A SYSTEM, THE RESULTING DESIGN MUST BE REVIEWED BY QUALIFIED PERSONNEL WHO ARE FAMILIAR WITH THE CONSTRUCTION AND OPERATION OF ALL COMPONENTS IN THE SYSTEM AND THE POTENTIAL HAZARDS INVOLVED.
IF THIS DEVICE IS USED IN AN AUTOMATIC OR MANUAL FILING CYCLE, ALL USERS MUST PROVIDE A HARD WIRED EMERGENCY STOP CIRCUIT OUTSIDE OF THE DEVICE CIRCUITRY.
FAILURE TO OBSERVE THESE PRECAUTIONS COULD RESULT IN BODILY INJURY!

When installing an 8142 where the setpoints outputs are used, several precautions must be taken to ensure reliable operation.

4.4.1. RFI Precautions

On desk and rack type enclosures install the RFI filtered 25 pin adapter (125862 00A) on the JW connector. Secure the adapter with the 2 standoffs (126244 00A). The RFI filtered adapter and standoffs are included with the 8142.

4.4.2. Power Precautions

The 8142 **MUST** be operated from a different AC power source than the power that is switched by the setpoint outputs.

4.4.3. Inductive Load Precautions

All inductive loads can generate a "back" EMF voltage spike of several thousand volts. If unsuppressed, this voltage spike can feed back into the 8142 and possibly cause erratic operation. To prevent voltage spike induced problems, all inductive loads switched by setpoints **MUST** have suppressors installed as close to the inductive load as possible. For DC power applications, install a reverse biased diode (124390 00A) across the coil. For AC power applications install a quencharc (118874 00A) across the coil.

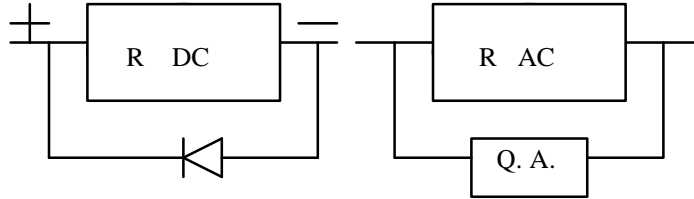

Figure 4-1: Setpoint Suppressors

In some applications it may be necessary to install quencharcs on large solenoids or relay coils that are physically near the scale or share power with setpoint outputs even though they are not switched by the 8142 setpoint outputs.

4.4.4. Static Discharge Precautions

Non-conductive materials (flour, plastic, rubber, etc.) can generate static electricity when fed onto a scale or hopper. The scale base or hopper, the 8142 and all conductive feeders to the scale (such as conveyors, chutes or pipes) must be electrically bonded together and attached to a true earth ground.

4.5. Programming and Calibration

	WARNING
Only permit qualified personnel to service this equipment. Exercise care when making checks, tests and adjustments that must be made with power on.	

	CAUTION
OBSERVE PRECAUTIONS FOR HANDLING ELECTROSTATIC SENSITIVE DEVICES.	

4.5.1. Keyboard Functions During Setup

The following keys perform the specified function during setup.

ENTER Key

Press the **ENTER** key to accept the displayed selection and advance to the next setup step.

SETUP Key

Press the **SETUP** key to enter setup mode. Press the **SETUP** key while in setup mode to accept the displayed selection and skip to **[S FILE]** at the end of setup.

ZERO Key

Press the **ZERO** key to accept the displayed selection and back-up to the previous setup step.

Numeric Keys

The numeric keys (**0 - 9**) are used to enter data as required. The **0** key is also used to display the next selection when a menu of choices is presented.

4.5.2. Accessing the Setup Mode

Refer to Figures 6-1 and 6-2 in Section 6.1. for setup jumper location.

For Single Display versions place the W2 jumper on the Main PCB so that it is shorting the two pins together.

For Dual Display versions place the W2 jumper on the Dual Display PCB so that it is shorting the two pins together. The W2 jumper is located on the BCD/Analog PCB if the optional BCD/Analog KOP is installed in a Dual Displayed Advanced, Rack enclosure version.

With the W2 Jumper (IN), press the **SETUP** key.

[CAL AJ] Span Adjust

The 8142 will advance to the span adjust step and the indicators will be flashing, if span adjustment is enabled, setup step **[F3.5 1]**. Press the **0** key or the **SETUP** key to skip the span adjust sequence and advance to the next setup step. Press the **1** key to access the span adjust sequence as described in Section 4.5.6.

Single Display versions will now advance to setup step **[F2.0 ?]**.

[000001] Consecutive Numbering Entry.

Dual and Dual Display Advanced versions now prompt for a consecutive number entry.

Press the **CLEAR** key to reset CN to 000001.

Enter a new beginning consecutive number by means of the numeric keys on the keyboard followed by the **SETUP** key. Note: This option is only available if preset CN has been enabled, setup step **[F6.4 1]**.

Press the **SETUP** key to accept the displayed CN and advance to the next step.

[HHMMSS] Time Entry

Dual and Dual Display Advanced versions now prompt for new time. Enter the time by means of the numeric keys on the keyboard followed by the **SETUP** key. The time is formatted as a 24 hour clock with 2 digits for hour, 2 digits for minutes and 2 digits for seconds.

Press the **SETUP** key to accept the displayed time and advance to the next step.

[MMDDYY] Date Entry

Dual and Dual Display Advanced versions now prompt for new date. Enter the date by means of the numeric keys on the keyboard followed by the **SETUP** key. The Date is entered in the same format as selected in setup step **[F5.13]**. The month is entered as a 2 digit number 01 for January - 12 for December. Enter the last 2 digits of the year only. Refer to Table 4-2 for date format selections.

F5.13 Selection	Date Format
F5.13 = 1 or 4	MM DD YY
F5.13 = 2 or 5	DD MM YY
F5.13 = 3 or 6	YY MM DD

Table 4-2: Date Format

[Print?] Print Setup

Dual and Dual Display Advanced versions allow all of the setup data to be printed if a printer is attached. The Model 8855 or 8843 printer is ideal for printing out setup parameters. The 8806 printer can be used if accumulation is disabled. DO NOT use a Model 307 or 8860 label printer for setup printout.

The 8142 will either exit setup or advance to step **[F2.0 ?]** depending upon the position of the setup jumper W2. Refer to Figures 6-1 and 6-2 in Section 6.1. for jumper location.

The 8142 setup procedure is broken up into groups of steps, each group is concerned with a different aspect of the setup procedure. Refer to the 8142 Quick Reference Chart for a brief list of selections and Sections 4.5.3.1. through 4.5.3.11. for detailed descriptions of each step and selections

4.5.3. Model 8142 Setup Quick Reference Chart

<u>STEP DESCRIPTION</u>	<u>SELECTIONS</u>	<u>STEP DESCRIPTION</u>	<u>SELECTIONS</u>
F2.0 Tare Group		F3.6 Display Under Zero	0 = Disabled 1 = Enabled
F2.1 Tare Mode	0 = Disable 1 = Keyboard/Auto 2 = Auto Tare Only	F3.7 Zero Adjust	0 = Bypass Zero Adjust 1 = Adjust Zero
F2.2 Tare Interlocks (*)	0 = Disable 1 = Enable	F4.0 AZM/Motion Group	
F2.3 Auto Clear Tare	0 = Disabled 1 = Enabled	F4.1 AZM Range (*)	0 = Disabled 5 = 0.5 Increment 10 = 1 Increment 20 = 2 Increment 30 = 3 Increment
F2.4 Net Zero Cursor (*)	0 = Disabled 1 = Enabled	F4.1A AZM Mode	0 = AZM Gross Mode Only 1 = AZM Net or Gross
F2.5 Keystroke Timeout	0 = Disabled 1 = Enabled	F4.2 Motion Range (*)	07 = 0.7 Increment
F2.6 Predetermined Tare	0 = Disabled 1 = Enable French W&M	F4.3 Motion Rate (*)	03 = 3 Updates
F2.7 Autoprint Threshold	0 = Disabled 1 = Enabled	F4.4 Digital Filtering	0 = Disabled 1 = Light Filter 2 = Medium Filter 3 = Heavy Filter 4 = Very Heavy Filter
F3.0 Power-up Group		F4.6 Analog Verify	0 = Disabled 1 = Enabled
F3.1 Power-up Timer	0 = Disabled 1 = Enabled	F4.7 Pushbutton Zero	0 = Disabled 1 = $\pm 2\%$ of Capacity 2 = $\pm 20\%$ of Capacity
F3.2 Power-up Units	0 = kg Weight Units 1 = lb Weight Units		
F3.3 Units Switching	0 = Disabled 1 = Enabled		
F3.4 Expanded Weight	0 = Disabled 1 = Enabled		
F3.5 Span Adjust	0 = Disabled 1 = Enabled		

(*) - Requires specific selection for legal-for-trade applications.
Recommended default selections are shown in ***Italics***.

Model 8142 Setup Quick Reference Chart Continued

<u>STEP DESCRIPTION</u>	<u>SELECTIONS</u>	<u>STEP DESCRIPTION</u>	<u>SELECTIONS</u>
F5.0 JN Printer Port Group		F5.12 (Continued)	7 = ID, T&D, CN WT T&D CN, WT 8 = ID
F5.1 JN Port Mode	1 = Demand (Printer) 2 = Toledo® Continuous 3 = Masstron® Continuous 4 = Toledo® Short Form	F5.13 Time/Date Format	0 = Disabled 1 = MM DD YY 2 = DD. MM. YY 3 = YY MM DD 4 = HH: MM PM MM DD YY 5 = DD. MM. YY HH: MM 6 = YY MM DD HH: MM
F5.2 JN RS-422 Input	0 = Disabled 1 = Enabled	F5.14 Print ID	0 = Disabled 1 = Enabled
F5.3 JN Baud Rate	1200 Baud	F5.15 Print CN	0 = Disabled 1 = Enabled
F5.4 JN Port Checksum	0 = Disabled 1 = Enabled	F5.16 Net Sign Print (*)	0 = Disabled 1 = Enabled 2 = Enable and removes sign
F5.5 Printer Model Select	1 = Standard 2 = 8805 (Receive Only) 3 = 8805 (Smart Mode) 4 = 8820/8830 (Ram 1) 5 = 8820/8830 (Ram 2, 3)	F5.17 ASCII Remote Input	0 = Disabled 1 = Command Input Enabled 2 = Demand/Continuous
F5.6 Weight Line Format	1 = Displayed Weight 2 = Single Line G, T, N 3 = Multi Line G, T, N	F5.18 Autoprint/Interlock	1 = Disabled 2 = Print Interlock 3 = Autoprint
F5.7 Double Width Print	0 = Disabled 1 = Enabled	F5.19 Additional Linefeeds	0 = Skip Linefeed Select 1 = Access Linefeed Select
F5.8 Minimum Print Increments		F5.20 DSR Input Mode	0 = CLEAR 1 = TARE 2 = PRINT 3 = ZERO 4 = Blank Display
F5.9 Printed Legend (*)	1 = "lb" or "kg" 2 = "t" for tons 3 = No Legend	F6.0 Recall Data and Clock Adjust Group	
F5.10 Negative Net Weight	0 = Disabled 1 = Enabled	F6.1 Recall ID	0 = Disabled 1 = Enabled
F5.11 Repeat Print	0 = Disabled 1 = Enabled	F6.2 Recall CN	0 = Disabled 1 = Enabled
F5.12 Demand Format	1 = WT, ID, T&D, CN 2 = ID T&D WT, CN 3 = ID T&D, CN WT 4 = ID T&D CN WT 5 = T&D ID CN WT 6 = T&D ID WT, CN	F6.3 Recall Time & Date	0 = Disabled 1 = Enabled
		F6.4 Preset CN	0 = Disabled 1 = Enabled
		F6.5 Recall Setpoint Data	0 = Disabled 1 = Enabled
		F6.6 Access Clock Adjust	

Model 8142 Setup Quick Reference Chart Continued

<u>STEP DESCRIPTION</u>	<u>SELECTIONS</u>	<u>STEP DESCRIPTION</u>	<u>SELECTIONS</u>
F7.0 Setpoint Programming Group		F9.0 JY Host Port Group	
F7.1 Setpoints Enable	<i>0 = Disabled</i> 1 = Enabled	F9.1 JY Port Enabled	<i>0 = Disabled</i> 1 = Enabled
F7.2 Setpoint Mode	2 = 2, Dual Speed Setpoints <i>4 = 4, Single Speed Setpoint</i>	F9.2 JY Port RS-485 Input	<i>0 = Disabled</i> 1 = Enabled
F7.3 Tolerance Mode	<i>0 = Setpoint Tolerance</i> 1 = Zero Tolerance	F9.3 JY Port Baud Rate	9600 Baud
F7.4 Zero Tolerance Entry	0 = Disabled <i>1 = Enabled</i>	F9.4 JY Port Parity	0 = Always a "0" 1 = Even Parity <i>2 = Even parity</i>
F7.5 Tolerance Entry	0 = Disabled <i>1 = Enabled</i>	F9.5 JY Port Stop Bits	<i>1 = 1 Stop Bit</i> 2 = 2 Stop Bits
F7.6 Setpoint Password	<i>0 = Disabled</i> 1 = Enabled	F9.6 JY Port Checksum	<i>0 = Disabled</i> 1 = Enabled
F8.0 JW Setpoint Port Group		F9.7 JY Port Address	2
F8.1 JW Port Tare Entry	<i>0 = Disabled</i> 1 = Enabled	F10.0 BCD/Analog Group	
F8.2 JW Port ID Entry	<i>0 = Disabled</i> 1 = Enabled	F10.1 Enable BCD/Analog Out	<i>0 = Disabled</i> 1 = Enabled
F8.3 Continuous Output	<i>0 = Disabled</i> 1 = Enabled	F10.2 Data Output Mode	<i>0 = Displayed Weight</i> 1 = Gross Weight Output
F8.4 JW Port Baud Rate	9600 Baud	F10.3 Disable BCD Dummy Zero	0 = Enable Dummy Zero <i>1 = Disable Dummy Zero</i>
F8.5 JW Port Parity	0 = Always a "0" 1 = Odd Parity <i>2 = Even Parity</i>	F11 Load Default Parameters	<i>0 = Skip</i> 1 = Reset to Default
F8.6 JW Port Stop Bits	<i>1 = 1 Stop Bit</i> 2 = 2 Stop Bits	CAL Calibration Group	
F8.7 JW Port Checksum	<i>0 = Disabled</i> 1 = Enabled	C1 Total Number of Displayed Increments (*)	
F8.8 Alpha Barcode Input	<i>0 = Disabled</i> 1 = Enabled	C2 Increment Size (1, 2 or 5) (*)	
		C3 Decimal Point Location (*)	
		C4 Linearity Correction	<i>0 = Disabled</i> 1 = Enabled
		C5 Overload Blanking (*)	<i>0 = Scale Capacity + 5 Increments</i>

(*) - Requires specific selection for legal-for-trade applications.
Recommended default selections are shown in ***italics***.

4.5.4. Setup Step Descriptions

[F2.0 ?] Access Tare Functions

Press:

0 - Skip tare setup and advance to step F3.0

1 - Advance to step 2.1

 WARNING
DO NOT OPERATE THE DUAL DISPLAY ADVANCED VERSION IN A SETPOINT APPLICATION WITH TARE INTERLOCKS ENABLED [F2.2 1]. FAILURE TO OBSERVE THIS PRECAUTION COULD RESULT IN BODILY INJURY.

[F2.1 1] Tare Active

Press:

0 - Disable all Tare functions

1 - Enable keyboard, pushbutton and remote tare

2 - Enable pushbutton and remote tare only

[F2.2 0] Tare Interlocks

Tare interlocks restricts certain weighing operations to satisfy legal-for-trade requirements. When tare interlocks are enabled the following restrictions apply:

- Tare can be taken only when the 8142 is in the gross weight mode.
- Keyboard tare can only be entered at gross zero.
- Tare can only be cleared at gross zero.
- Tare interlocks disable the weight cursor (lb or kg) blanking to indicate motion.
- The 8142 will display [**E E E**] for weights above gross zero and will display [**-E E E**] for weight below gross zero on power-up until zero has been captured either by the auto zero capture function or by pressing the ZERO key.

Press:

0 - Disable Tare Interlocks

1 - Enable Tare Interlocks

[F2.3 0] Auto Clear Tare

When enabled, tare will be cleared when the scale returns to within $\pm\frac{1}{4}$ displayed increment of gross zero after having settled on a no motion weight greater than 10 increments above net zero.

Press:

0 - Disable auto clear tare

1 - Enable auto clear tare

[F2.4 0] Net Zero Cursor

This option is included for export applications and should be disabled for U.S.A. applications.

Press:

- 0 - Disable net zero cursor, the zero cursor will illuminate at gross zero only.
- 1 - Enable net zero cursor, the zero cursor will illuminate at both gross and net zero.

[F2.5 0] Keystroke Timeout

Press:

- 0 - Disable timeout, the 8142 will wait for operator to finish data entry for an unlimited time.
- 1 - Enable 3 second timeout. During keyboard data entry, if more than 3 seconds pass between keystrokes the 8142 will abort the keyboard data entry and return to normal weighing mode.

[F2.6 0] Predetermined Tare (French Weights and Measures)

Press:

- 0 - Disable predetermined tare
- 1 - Enable predetermined tare

This step is for export applications only. All domestic applications require this step be disabled. If enabled, predetermined tare locks the 8142 into the kg weight mode only. The lb cursor is redefined as the PT (predetermined tare) cursor and illuminates when a keyboard tare is entered.

Keyboard Entered Tare:

Keyboard entered tare weights are not displayed in the auxiliary display. A keyboard entered tare weight can be displayed by pressing the RECALL key. The weight display shows the keyboard entered tare value. Keyboard entered tare weights are printed with a "PT" legend after them in the demand mode output.

Pushbutton Tare:

Pushbutton tare weights are displayed in the auxiliary display. Pushbutton tare weights are printed with a "T" after them in the demand mode output.

NOTE: If (F2.6) enabled steps (F3.2 & F3.3) will be skipped in setup.

[F2.7 0] Autoprint Threshold

Press:

- 0 - Disable autoprint threshold
- 1 - Enable autoprint threshold

This step is for export application only. This step is not displayed in setup for domestic applications. Autoprint at threshold is only available if predetermined tare is enabled [F2.6 1]. This step will cause an autoprint to occur if the weight on the scale changes more than the threshold value entered in setup.

[F3.0 ?] Access Power-up Functions

Press:

- 0 - Skip power-up setup and advance to step F4.0
- 1 - Advance to step 3.1

F3.1 0] Power-up Timer

If the power-up timer is enabled, the weight display will remain blank and the cursors will blink for 30 seconds after power-up to allow the circuitry time to reach operating temperature.

Press:

- 0 - Disable power-up timer
- 1 - Enable power-up timer

[F3.2 1] Power-up Units

This step selects the weighing units (lb or kg) the 8142 will use at power-up.

Press:

- 0 - Select kg units
- 1 - Select lb units

[F3.3 1] Units switching

Press:

- 0 - Disable units switching
- 1 - Enable lb/kg switching

Note: If units switching is disabled (step [F3.3 0]) and power-up kg is selected (step [F3.2 0]) the JN printer port demand output uses a comma in place of the decimal point and a "NETC" will replace the "NET" legend in the demand mode output if a keyboard tare is entered.

[F3.4 0] Expanded Weight Display

When expanded weight display is enabled, the weight field will display internal counts, 10 times normal displayed resolution. Tare, Zero and Data output functions are disabled in this mode.

Press:

- 0 - Disable expanded weight mode
- 1 - Enable expanded weight mode

Note: **DO NOT** leave the 8142 in the expanded weight display mode for normal weighing. The expanded weight display mode is for troubleshooting purposes only.

[F3.5 0] Span Adjust

This step enables the span adjust step described in Section 4.5.4. The normal calibration procedure described in section 4.5.3.10. must be performed before the span adjust procedure can be used.

Press:

- 0 - Disable span adjust
- 1 - Enable span adjust

[F3.6 1] Extended Under Zero Display

When this step is enabled, the 8142 will display a minimum of 5% of capacity below gross zero. If disabled, the 8142 will blank for any negative weights more than 5 increments under gross zero. Continuous format output is inhibited while the 8142 is displaying blank under zero.

Press:

- 0 - Disable extended under zero display
- 1 - Enable extended under zero display

[F3.7 0] Zero Reference Adjust

This step allows the 8142 to capture a new zero reference. Up to $\pm 20\%$ of programmed scale capacity can be zeroed AFTER the scale has been calibrated using the normal calibration procedure. This new zero reference is stored during power loss and is the zero reference used during power-up. Zero adjust is disabled when the 8142 is blanked under capacity, blanked over capacity or in the expanded weight display mode. To use the zero adjust step empty the scale and enter setup. Step through setup until step [F3.7] is displayed then.

Press:

- 0 - Bypass the zero adjust step
- 1 - To store the current weight on the scale as the new zero reference.

[F4.0 ?] Access AZM/Averaging

Press:

- 0 - Skip AZM/Averaging setup and advance to step F5.0
- 1 - Advance to step 4.1

[F4.1 05] Auto Zero Maintenance

AZM (Auto zero maintenance) is a feature that maintains the displayed zero in the center of the zero division. This step selects the size of the window over which zero change will be compensated for at the rate of 0.1 increments per second. If the weight exceeds the AZM window then AZM is disabled. As long as the weight is within the AZM window selected, the 8142 will remove 0.1 increments of the zero change per second.

AZM corrects for zero change in the selected AZM window up to the pushbutton zero range (selected in setup step F4.7) of either $\pm 2\%$ or $\pm 20\%$ of scale capacity.

Press:

- 0 - To accept the displayed selection
- 1 - Display next selection

Selection	AZM Window	Legal-For-Trade Applications
0	AZM Disabled	Not Applicable
5	± 0.5 Increment	Animal, Food and Retail Scales
10	± 1 Increment	All other Industrial Scales
20	± 2 Increment	Not Applicable
30	± 3 Increment	Vehicle Scales

[F4.1A 0] AZM In Gross Weight Mode or Gross and Net Weight Mode

Press:

- 0 - AZM at gross zero in gross weight mode
- 1 - AZM at gross zero in net or gross weight mode

AZM in the gross and net mode permits the 8142 to compensate for small changes in zero any time the scale is at gross zero, even though the scale is in the net mode.

[F4.2 07] Motion Detect Window

This step sets up a zone within which the weight reading can change without tripping the "in motion" detector. The weight is "in motion" unless the weight on the scale remains within the motion detect window for as many display updates as are selected in the motion detect rate, step [F4.3].

The motion detect window selection is in minor increments, 0.1 display increments. Valid selections are from 0 to 30, with 07 recommended as a starting value. Legal-for-trade application require the motion detect window be set for 07. Print, tare, clear, AZM and pushbutton zero functions are disabled when the scale is "in motion".

Enter the motion detect window value. If only 1 digit is entered, press the ENTER key to proceed. If 2 digits are entered the 8142 will automatically advance to the next step. Press the CLEAR key to display the previous value.

Note: Enter a value of 0 to disable motion detection, skip Step [F4.3] and disable autoprnt/interlock.

[F4.3 03] Motion Detect Rate

This step selects the number of display updates the weight reading must stay within the motion detect window to be considered a "no motion" condition. Enter the motion detect rate value. If only 1 digit is entered, press the ENTER key to proceed. If 2 digits are entered the 8142 will automatically advance to the next step. Press the CLEAR key to display the previous value.

Note: Use a motion detect rate of 5 or 6 for setpoint applications.

[F4.4 1] Digital Filtering

The digital filter provides a more stable display in the presence of vibration.

Press:

- 0 - To accept the displayed selection
- 1 - Display next selection

Selection	Filter Selection
0	Filter Disabled
1	Light Filter
2	Medium Filter
3	Heavy Filter
4	Very Heavy Filter

Note: Heavy filtering effects settling time, disable filtering for Setpoint batching applications.

[F4.6 0] Analog Verify

The analog verify feature performs a test every four hours of the A/D converter, located on the Main PCB. If the analog verify test fails an error code E8 will be displayed and the 8142 will not function until the 8142 is recalibrated. Analog verify **MUST NOT** be used with scale builds over 10,000 increments.

Press:

- 0 - Disable analog verify
- 1 - Enable analog verify

[F4.7 1] Pushbutton Zero Capture Range

Press:

- 0 - Display next selection
- 1 - To accept the displayed selection

Selection	Pushbutton Zero Capture Range
0	Disabled
1	±2% of Capacity
2	±20% of Capacity

[F5.0 ?] Access JN Printer Port Programming

Press:

- 0 - Skip JN port setup and advance to next setup group
- 1 - Advance to step 5.1

[F5.1 1] Output Mode

This step selects the "JN" port data output mode. The 8142 provides demand and continuous output in a 7 data bit, even parity, 1 stop bit format.

The demand mode is used for interfacing Toledo® printers and for simple computer interfacing. Demand mode output is disabled when the 8142 is in a "motion" condition, under gross zero or over capacity.

The continuous output provides interfacing to accessories and for real time computer interfacing. The 8142 provides three versions of the continuous output mode.

The Toledo® continuous mode is the standard communication mode used by remote displays and for communication with various Toledo accessories (scale terminals, batch controllers).

The Masstron® Continuous mode provides compatibility with Masstron® accessories.

The Toledo® Short Continuous mode is a new high speed communication mode designed to provide most of the features of the standard Toledo® continuous mode and allow the fastest possible display update rate. **Standard Toledo® accessories are not compatible with this format.**

Press:

- 0 - Display next selection
- 1 - To accept the displayed selection

Selection	Data Output Mode
1	Demand
2	Toledo® Continuous
3	Masstron® Continuous
4	Toledo® Short Continuous

Note: If continuous data format is selected, step **[F5.1]** = 2, 3, or 4 then setup steps F5.5, F5.6, F5.7, steps F5.9 through F5.16 and step F5.19 are skipped.

Note: Printing is enabled behind gross zero depending on F3.6.

[F5.2 0] Input Selection

The 8142 JN printer port can provides bi-directional communication for both the RS-232C and 20 mA current loop interfaces. The JN port RS-422 interface is output only. This step

Press:

- 0 - Either 20 mA current loop or RS-232C input is selected
- 1 - Select RS-422 input

[F5.3] [3 300] Baud Rate

Baud rate selections for the demand mode output are 300, 1200, 2400, 4800 and 9600 baud. The continuous mode eliminates the 300 baud selection. For the fastest display update rate, use the fastest possible baud rate when continuous output is in use.

Press:

- 0 - Display next selection
- 1 - To accept the displayed selection

[F5.4 0] Checksum

Checksum is an error detection scheme that checks the integrity of the entire string of data that is transmitted. Checksum is defined as the 2's complement of the sum of the 7 low order bits of all characters transmitted, beginning with the <STX> character, ASCII hex (02) to the last character before the checksum.

Press:

- 0 - Disable checksum
- 1 - Enable checksum

Note: If continuous data format is selected, step **[F5.1]** = 2, 3, or 4 then setup will skip to step **[F5.8]**.

[F5.5 1] Printer Select

This step is included to provide compatibility with older Toledo® printers. Printer select should be set to a 1 for computer interfacing applications. Selections other than a 1 add either a 1 second or two second time delay between each line of data output. The different selections for the 8805 and 8820/30 Printers are required to determine how the remote pulse input is interpreted.

Press:

- 0 - Display next selection
- 1 - To accept the displayed selection

Selection	Printer Model	Added Time Delay	Remote Pulse Input
1	307, 8804, 8806, 8843, 8855, 8860, Computers	None	Print
2	8805 (Receive Only Mode)	1 Second	Busy
3	8805 (Smart Mode)	1 Second	Print
4	8820/30 (Ram 1)	2 Seconds	Busy
5	8820/30 (Ram 2, 3)	2 Seconds	Print

[F5.6 3] Weight Data Line Format

This step selects single or multiple line printing for the weight data fields.

Press:

- 0 - Display next selection
- 1 - To accept the displayed selection

Selection	Weight Field Printed	Line Format
1	Displayed Weight	Single
2	Gross, Tare, Net	Single
3	Gross, Tare, Net	Multiple

[F5.7 0] Double Width Print

An ASCII shift out (SO), and an ASCII shift in (SI), character is inserted in the data transmission to select double width printing for the gross weight field (net weight field if a tare has been taken).

Press:

- 0 - Disable double with printing
- 1 - Enable double width printing

[F5.8 0] Minimum Print

The displayed weight must exceed the minimum print selection to allow a print function to occur. Valid selections are 0, 10, 20 and 30 increments.

Press:

- 0 - Display next selection
- 1 - To accept the displayed selection

Note: If continuous data format is selected, step [F5.1] = 2, 3, or 4 then setup will skip to step [F5.17].

[F5.9 1] Print Units Legend

This step selects the units legend that is included in the demand format output. Lb/kg switching **MUST** be disabled, step [F3.3 0] if "t" weight units is selected.

Press:

- 0 - Display next selection
- 1 - To accept the displayed selection

Selection	Legend
1	"lb" or "kg"
2	"t" for tons
3	No legend

[F5.10 1] Negative Net Weight Printing

Press:

- 0 - Disable printing when below net zero
- 1 - Enable printing when below net zero

[F5.11 0] Repeat Print

Press:

- 0 - Disable repeat print
- 1 - Enable repeat print

If repeat print is enabled, subsequent print request without a change in weight on the scale will cause an exact duplicate of the previous printed output. Consecutive numbering and time and date values printed using repeat print will not change until there is a motion/no motion transition between print requests.

[F5.12 4] Demand Output Format

Press:

- 0 - Display next selection
- 1 - To accept the displayed selection

Selection	Demand Format Output
1	WT, ID, T&D, CN
2	ID, T&D, WT, CN
3	ID, T&D, CN, WT
4	ID, T&D, CN, WT
5	T&D, ID, CN, WT
6	T&D, ID, WT, CN
7	ID, T&D, CN, WT
8	ID, T&D, CN, WT

Note: WT = weight fields, CN = consecutive numbering, T & D = time and date, ID = Identification.

[F5.13 4] Time and Date Format

Press:

- 0 - Display next selection
- 1 - To accept the displayed selection

Selection	Time and Date Format
0	No Time and Date
1	MM DD YY
2	DD. MM. YY
3	YY MM DD
4	HH: MM PM MM DD YY
5	DD. MM. YY HH: MM
6	YY MM DD HH: MM

Note: MM = month, DD = day, YY = last 2 digits of the year, HH:MM = hours and minutes.

[F5.14 1] Transmit ID

Press:

- 0 - Disable ID output
- 1 - Enable ID output

[F5.15 1] Transmit CN

Press:

- 0 - Disable CN Output
- 1 - Enable CN Output

[F5.16 0] Sign Corrected Net Weight

When this step is enabled the 8142 prints the absolute value of the net weight. If a ticket is printed when a negative net weight is displayed on the scale the 8142 reverses tare and gross weights so that the result printed is a positive net weight. Step [F5.10 1] must be selected to allow sign corrected net weight printing.

Press:

- 0 - Disable sign corrected net weight printing
- 1 - Enable sign corrected net weight printing
- 2 - Enable sign correction and remove sign from display and print

Example of sign corrected net weight printing:

A loaded truck pulls on the scale and weighs 25,000 lb. The operator presses the TARE key to tare off the weight of the truck. The truck is unloaded and then returns to the scale. The empty weight of the scale is 10,000 lb. The displayed weight with the empty truck on the scale is -15,000 lb. The two printouts shown next depict the printer output with F5.16 enabled and disabled.

[F5.16 0] 10,000 Gross
 25,000 Tare
 -15,000 Net

[F5.16 1] 25,000 Gross
 10,000 Tare
 15,000 Net

[F5.17 0] ASCII Remote Command Input

This step controls the single ASCII character input to the JN printer port. Remote clear, print, tare, and zero functions are available. The JN port will output one Toledo® continuous or Toledo® Short Continuous format message every time an <ENQ> character, ASCII Hex (05), is received if the Demand/Continuous Mode is selected, step [F5.17 2].

Press:

- 0 - Display next selection
- 1 - Accept the displayed selection

Selection	ASCII Input Mode	Remote Print, Pulse Input
0	Input Disabled	Enabled
1	ASCII Command Input	Disabled
2	Demand/Continuous Mode	Disabled

- Notes:**
- **ASCII Remote Command Input MUST be disabled [F5.17 0] to use the Remote Print Input from the 8806 printer.**
 - **Demand/Continuous Mode is provided for computer interfacing only. Toledo Scale peripherals that use continuous mode WILL NOT operate in the Demand/Continuous mode.**

[F5.18 1] Print Interlock/Autoprint

PRINT INTERLOCK

Print interlock prevents repeated output of the same weight data by requiring the weight on the scale to return to net zero before demand data output can occur. The print interlock/autoprint resets at net zero or gross zero if a tare has not been taken. The motion detect window, step [F4.2], MUST be set to a nonzero value for print interlock or autoprint to function.

If the displayed weight is within 10 increments of zero, output can be initiated as desired, assuming all other output requirements are met.

If the displayed weight is greater than 10 increments above zero only one print can be initiated. The display must then return to within 10 increments of zero, see "no motion", then exceed 10 increments above net zero and see "no motion" before another output is allowed.

Note: Print Interlock does not work in E rev. software.

AUTOPRINT

Autoprint allows automatic output when the displayed weight settles to a "no motion" weight above the minimum print selection, step [F5.8]. The displayed weight must return to a "no motion" weight less than the minimum print selection, then settle on a "no motion" weight above the minimum print selection before another autoprint occurs. Autoprint disables the Print key.

Press:

- 0 - Display next selection
- 1 - Accept the displayed selection

Selection	Print Interlock/Autoprint Mode
1	No print interlock or autoprint
2	Enable Print Interlock Mode
3	Enable Autoprint

Note: If continuous data format is selected, step [F5.1] = 2, 3, or 4 then setup will skip step [F5.19].

[F5.19] Additional Linefeeds After Printout

The 8142 demand mode adds from 0 to 99 extra linefeeds after the last data field is transmitted.

Press:

- 0 - To skip linefeed programming and advance to the next setup step
- 1 - To access linefeed programming

[00] Enter Additional Linefeeds

Enter the number of additional linefeeds desired using the numeric keys on the keyboard. Press the CLEAR key to reset additional linefeeds to 00. Press the Enter key to accept the displayed number of additional linefeeds and advance to the next setup step.

Note: Single display versions advance to the calibration group [CAL ?].

[F5.20 2] Data Set Ready (DSR) Pulse Input Selection

Press:

- 0 - Display next selection
- 1 - Accept the displayed selection

Selection	Function	Input type
0	Clear	Momentary
1	Tare	Momentary
2	Print	Momentary
3	Zero	Momentary
4	Blank	Momentary

- The RS-232 (DSR) Data Set Ready input, pin 6 on the JN port, can be configured for use as a remote clear, tare, print or zero momentary contact closure input or can be used as a remote blank display input.
- The remote clear, tare, print and zero inputs are momentary inputs. Momentarily ground the DSR input for from .3 to 3 seconds to actuate these functions.
- The blank function will blank the weight and auxiliary display and inhibit all data output as long as the DSR input is connected to ground.

***Note:** Remote (DSR) input allows installation of a switch across pins 6 & 7 to use remote clear, tare, print, or zero.

[F6.0 ?] Access Recall and Clock Adjust

Press:

- 0 - Skip recall data and clock adjust setup and advance to next setup group
- 1 - Advance to step F6.1

[F6.1 1] Recall ID

Press:

- 0 - Disable recall of ID
- 1 - Enable recall of ID

[F6.2 1] Recall Consecutive Numbering

Press:

- 0 - Disable recall of CN
- 1 - Enable recall of CN

[F6.3 1] Recall Time and Date

Press:

- 0 - Disable recall of time and date
- 1 - Enable recall of time and date

[F6.4 1] Preset Consecutive Numbering

If CN preset is enabled, CN can be preset to any 6 digit number as well as reset to 000001.

Press:

- 0 - Disable CN preset
- 1 - Enable CN preset

[F6.5 1] Recall Setpoint data

Press:

- 0 - Disable recall of setpoint data
- 1 - Enable recall of setpoint data

[F6.6 0] Access Clock Adjust

This step allows adjustments to be made to the 8142 time of day clock. To make this adjustment first determine the error in minutes and second, over a 24 hour period. Then enter the clock error into the 8142 as described next. The clock adjust step can be disabled without erasing the correction factor.

Press:

- 0 - Disable clock adjust without erasing correction factor
- 1 - Access clock adjust programming
- ENTER - To skip clock adjust step programming without changing setup

[CL AJ?] Access New Clock Adjust Value Entry

Press:

- 0 - Disable clock adjust without erasing correction factor
- 1 - Access new clock adjust value entry
- ENTER - To skip new clock adjust value entry and advance to correction sign entry

[M.SS] Enter New Clock Adjust Value

M = Minutes SS = Seconds

Enter the new clock adjust value using the numeric keys on the keyboard. If less than 3 digits of clock adjust value is entered then terminate the data entry with the ENTER key.

Press: The **ENTER** key to accept the displayed value.

[Add? X] Correction Sign Entry

Press:

- 0** - To select a negative correction sign. This selection is used when the 8142 clock runs fast.
- 1** - To select a positive correction sign. This selection is used when the 8142 clock runs slow.

Note: Dual display versions will advance to the calibration group, **[CAL]**, after recall data setup.

[F7.0 ?] Access Setpoint Programming

Press:

- 0** - Skip setpoint setup and advance to next setup group
- 1** - Advance to step F7.1

[F7.1 1] Setpoint Enable

Press:

- 0** - Disable setpoint operation
- 1** - Enable setpoint operation

[F7.2 2] Setpoint Mode Select

The 8142 provides two modes of setpoint operation the 2 setpoint or the 4 setpoint mode.

The 2 setpoint mode supplies outputs for 2, dual speed setpoints with independent setpoint, dribble, preact and tolerance variables. The tolerance outputs are usable as either weight tolerances or zero tolerance outputs.

The 4 setpoint mode supplies outputs for 4, single speed setpoints with zero tolerance outputs.

Press:

- 0** - Toggle between 2 setpoint and 4 setpoint selection
- 1** - Accept the displayed selection

Note: If the 4 setpoint mode is selected then step **[F7.3]** is skipped.

[F7.3 1] Tolerance Output Mode Select

The 8142 supplies 2 tolerance outputs that can be used to indicate an out of tolerance weight for each setpoint (2 setpoint mode only) or can be used as a zero output. The zero output mode is useful for determining that the scale is empty before a batch cycle is started and can also be used as a discharge cutoff.

Press:

- 0** - Setpoint Tolerance Mode
- 1** - Zero Tolerance Mode

Note: If setpoint tolerance mode is selected, then step **[F7.4]** is skipped. If zero tolerance mode is selected, then step **[F7.5]** is skipped.

Note: Tolerance Output Mode can be used to turn on an "out of tolerance" bulb, whistle, etc. or to start a mixer or batching cycle.

Note: Setpoint output mode is shut off only when the display blanks depending on F3.6.

[F7.4 0] Keyboard Zero Tolerance Entry

Keyboard entry of the zero tolerance can be disabled if desired. The zero tolerance value can be programmed by the JY host port even when keyboard programming is disabled.

Press:

- 0 - Disable keyboard entry of zero tolerance
- 1 - Enable keyboard entry of zero tolerance

[F7.5 0] Keyboard Setpoint Tolerance Entry

Keyboard entry of setpoint tolerances can be disabled if desired. The setpoint tolerance values can be programmed by the JY host port even when keyboard programming is disabled.

Press:

- 0 - Disable keyboard entry of setpoint tolerance
- 1 - Enable keyboard entry of setpoint tolerance

[F7.6 0] Setpoint Entry Password

Press:

- 0 - Disable setpoint password
- 1 - Enable setpoint password

This step permits entry of a supervisors password to restrict operator access to setpoint data entry. If password is enabled the 8142 will display **[PASS]** for a few seconds then display: **[XXXXXX]** where XXXXXX is the current password. Enter from 1 to 6 digits for the new password then press the **ENTER** key. This password can only be changed in the setup mode.

[F8.0 ?] Access JW Port

Press:

- 0 - Skip JW port setup and advance to next setup group
- 1 - Advance to step F8.1

[F8.1 0] Remote Digital Tare Entry

The JW port can accept 6 digits of tare weight data followed by a <CR>. Nonnumeric characters such as spaces or letters are not allowed in the tare or ID field except as trailing characters in the field when bar code input, step **[F8.8 1]**, is selected.

Input of remote tare or ID does not inhibit the normal keyboard entry of tare or ID and is treated exactly as if hand entered on the 8142 keyboard. If both remote tare entry and remote ID entry are enabled, **[F8.1 1]** and **[F8.2 1]**, then the tare weight field must be sent first and the ID field second followed by a <CR>. The input format is:

TTTTTTNNNNNN<CR>

TTTTTT = Tare weight including optional decimal point.

NNNNNN = Numeric ID

<CR> = ASCII Carriage Return, Hex (0D)

Press:

- 0 - Disable remote tare entry
- 1 - Enable remote tare entry

[F8.2 0] Remote ID Entry

The JW port can accept six digits of numeric ID data followed by a <CR>. See description for [F8.1]

Press:

- 0 - Disable remote ID entry
- 1 - Enable remote ID entry

[F8.3 0] JW Port Continuous Data Output

This Step controls JW port continuous data output only. JW port data input is now controlled entirely by steps [F8.1] and [F8.2]:

Press:

- 0 - Disable JW Port Continuous Data Output
- 1 - Enable JW Port Continuous Data Output

NOTES: If both remote digital tare and ID entry is disabled, steps [F8.1 0] and [F8.2 0], then remote control single character ASCII inputs is enabled. If either remote digital tare or ID entry is enabled, steps [F8.1 1] or [F8.2 1], then remote control single character ASCII input is disabled.

[F8.4] [4 9600] JW Port Baud Rate

Baud rate selections for the JW port are 1200, 2400, 4800 and 9600 baud. Use the fastest possible baud rate for the fastest display update rate.

Press:

- 0 - Display next selection
- 1 - To accept the displayed selection

[F8.5 2] JW Port Parity

The parity bit is provided to detect errors in output and input of ASCII data. The JW port transmits and receives ASCII data in a 7 data bit format plus a selectable parity bit. The parity bit must be selected to match the external device requirements. Toledo Scale products normally use even parity. If parity bit always a "0" is selected, [F8.5 0], the JW port format is equivalent to 8 data bits, no parity, with the 8th data bit always equal to a "0".

Press:

- 0 - Display next selection
- 1 - To accept the displayed selection

Selection	Parity Bit Selection
0	Parity Bit Always a "0"
1	Odd Parity
2	Even Parity

[F8.6 1] JW Port Stop Bits

Press:

- 0 - To toggle between 1 or 2 stop bits
- 1 - To accept the displayed selection

[F8.7 0] JW Port Checksum

Checksum is defined as the 2's complement of the sum of the 7 low order bits of all characters transmitted, beginning with the <STX> character, ASCII hex (02) to the last character before the checksum.

Press:

- 0 - Disable checksum
- 1 - Enable checksum

[F8.8 0] JW Port Barcode Input

The 8142 normally ignores remote tare remote id input if any nonnumeric characters are received. This step **MUST** be enabled if remote tare or remote ID is to be read into the JW port, step [F8.1 1] or [F8.2 1], from a label printed on the Model 8860 bar code printer.

Press:

- 0 - Disable nonnumeric character input
- 1 - Enable nonnumeric character input

Note: The 8142 allows numeric ID only, alpha characters will not be accepted as ID.

[F9.0 ?] Access JY Port

The optional Host Communication K.O.P. allows remote operation of the 8142 and setpoint data to be downloaded into the 8142. Refer to Section 6.6. for a complete description of the JY Host port.

Press:

- 0 - Skip JY port setup and advance to next setup group
- 1 - Advance to step F9.1

[F9.1 0] Enable JY Host Port

Press:

- 0 - Disable JY port
- 1 - Enable JY port

[F9.2 0] Multidrop RS-485 Communication

This step selects between single scale, RS-232C or multidrop RS-485, (two wire, half duplex) mode of operation. The JY port **MUST** be set to RS-232 mode if not using the RS-485 interface.

Press:

- 0 - Select RS-232C operation
- 1 - Select RS-485 multidrop operation

[F9.3] [3 9600] JY Port Baud Rate

Baud rate selections for the JY port are 1200, 2400, 4800 and 9600 baud.

Press:

- 0 - Display next selection
- 1 - To accept the displayed selection

[F9.4 2] JY Port Parity

The JY port transmits and receives ASCII data in a 7 data bit format with a selectable parity bit. If parity bit always a "0" is selected, [F9.4 0], the JY port format is 8 data bits, no parity.

Press:

- 0 - Display next selection
- 1 - To accept the displayed selection

Selection	Parity Bit Selection
0	Parity Bit Always a "0"
1	Odd Parity
2	Even Parity

[F9.5 1] JY Port Stop Bits

Press:

- 0 - To toggle between 1 or 2 stop bits
- 1 - To accept the displayed selection

[F9.6 0] JY Port Checksum

Checksum is defined as the 2's complement of the sum of the 7 low order bits of all characters transmitted, beginning with the <STX> character, ASCII hex (02) to the last character before the checksum.

Press:

- 0 - Disable checksum
- 1 - Enable checksum

[F9.7 2] Scale Address

The JY communication requires that each 8142 on the multidrop RS-485 network have its own unique address. Valid scale address are from 2 through 9. The scale address is used by the communication protocol even when used in the RS-232C mode with a single 8142.

Press:

- 0 - Display next selection
- 1 - To accept the displayed selection

[F10.0 ?] Access BCD/Analog

The optional BCD/Analog KOPs are for use with the wall and rack enclosure, dual display advanced versions only. Refer to Section 6.7. for a detailed description of the BCD/Analog option.

Wall mount, dual display advanced 8142's use K.O.P., Factory number 0917-0104.
Rack mount, dual display advanced 8142's use K.O.P., Factory number 0917-0105.

Press:

- 0 - Skip BCD/Analog setup and advance to calibration group
- 1 - Advance to step F10.1

[F10.1 0] Enable BCD/Analog Option

Press:

- 0 - Disable BCD and analog outputs
- 1 - Enable BCD and analog outputs

[F10.2 0] Data Output Mode

Press:

- 0 - BCD/Analog will output displayed weight
- 1 - BCD/Analog will output gross weight only

[F10.3 1] BCD Dummy Zero Disable

The BCD output can operate in a Model 8132 compatibility mode with 5 active digits and no dummy zero. The normal 8142 mode uses 5 active digits and includes a dummy zero if appropriate.

Press:

- 0 - Enable dummy zero
- 1 - Disable dummy zero

[F11.0 ?] Load Default Setup Parameters

This step controls access to the load default setup parameters. If this step is accessed all setup steps are reset to the default parameters listed in Table 1.

Press:

- 0 - Skip Load Default Setup Parameters, Display Advances to [CAL ?].
- 1 - Access Load Default Setup Parameters, Display Advances to [SUrE ?].

[SUrE ?] Are You Sure You Want to Load Default Setup Parameters

Press:

- 0 - Skip Load Default Setup Parameters.
- 1 - Load Default Setup Parameters as listed in Table 1.

After the operator presses a key (0 or 1) the 8142 then advances to the [CAL ?] display prompt.

<u>STEP</u>	<u>DESCRIPTION</u>	<u>SELECTIONS</u>
F2.1	Tare Active	1
F2.2	Tare Interlocks	0
F2.3	Auto Clear Tare	0
F2.4	Net Zero Cursor	0
F2.5	Keystroke Timeout	0
F2.6	Predetermined Tare	0
F2.7	Autoprint Threshold	0
F3.1	Power-up Timer	0
F3.2	Power-up Units	1
F3.3	Units Switching	1
F3.4	Expanded Weight	0
F3.5	Span Adjust	0
F3.6	Display Under Zero	1
F4.1	AZM Range	05
F4.1A	AZM Gross/Net Mode	0
F4.2	Motion Range	07
F4.3	Motion Rate	03
F4.4	Digital Filtering	1
F4.6	Analog Verify	0
F4.7	Pushbutton Zero	2

<u>STEP</u>	<u>DESCRIPTION</u>	<u>SELECTIONS</u>
F5.1	JN Port Mode	1
F5.2	JN RS-422 Input	0
F5.3	JN Baud Rate	1200
F5.4	JN Port Checksum	0
F5.5	Printer Model Select	1
F5.6	Weight Line Format	2
F5.7	Double Width Print	0
F5.8	Minimum Print	0
F5.9	Printed Legend	1
F5.10	Negative Net Weight	1
F5.11	Repeat CN Print	0
F5.12	Demand Format	1
F5.13	Time/Date Format	4
F5.14	Print ID	1
F5.15	Print CN	1
F5.16	Net Sign Print	0
F5.17	ASCII Remote Input	0
F5.18	Autoprint/Interlock	1
F5.19	Additional Linefeeds	00
F5.20	(DSR) Input Select	2

<u>STEP</u>	<u>DESCRIPTION</u>	<u>SELECTIONS</u>
F6.1	Recall ID	1
F6.2	Recall CN	1
F6.3	Recall Time & Date	1
F6.4	Preset CN	1
F6.5	Recall Setpoint Data	1
F6.6	Access Clock Adjust	0
F7.1	Setpoints Enable	0
F7.2	Setpoint Mode	4
F7.3	Tolerance Mode	0
F7.4	Zero Tolerance Entry	1
F7.5	Tolerance Entry	1
F7.6	Setpoint Entry Password	0
F8.1	JW Port Tare Entry	0
F8.2	JW Port ID Entry	0
F8.3	JW Port Mode	0
F8.4	JW Port Baud Rate	9600
F8.5	JW Port Parity	2
F8.6	JW Port Stop Bits	1
F8.7	JW Port Checksum	0
F8.8	Alpha Barcode Input	0
F9.1	JY Port Enabled	0
F9.2	JY Port RS-485 Input	0
F9.3	JY Port Baud Rate	9600
F9.4	JY Port Parity	2
F9.5	JY Port Stop Bits	1
F9.6	JY Port Checksum	0
F9.7	JY Port Address	2
F10.1	Enable BCD/Analog Out	0
F10.2	Data Output Mode	0
F10.3	Disable BCD Dummy Zero	1

[CAL ?] Access Calibration Setup

Press:

- 0** - Skip calibration and advance to **[S File]**
- 1** - Advance to **[C1]**

Allow a minimum of 15 minutes for warm-up before attempting to calibrate an 8142 indicator. This warm-up time allows the 8142 analog circuitry and the load cells to reach operating temperature.

Note(s):

- Error codes are redefined during the calibration procedure. For example: An E8 error during calibration means "illegal test weight value has been entered" NOT "analog verify error". Error codes are listed in Section 7.2.
- The 8142 will calibrate in the weight units displayed when setup was entered. If lb/kg switching is enabled, verify that the 8142 is in the correct weight units when setup is entered for calibration purposes.
- The capacity and increment size selections are entered as 3 variables calculated as described next.

[C1]- Total Increments = Capacity ÷ Increment Size
50 lb ÷ 0.005 lb = 10,000 Total Increments

[C2]- Increment type = 1, 2 or 5

[C3]- Decimal Point location from 0.0000X to X00

[C1] [5000] Total Increments

Total increment selections are 600, 1000, 1200, 1500, 2000, 2500, 3000, 4000, 5000, 6000, 8000, 10000, 12000, 15000, 16000, 20000, 25000, 30000, 32000, 35000, 40000, 45000, 48000, 50000.

Press:

- 0** - Display next selection
- 1** - To accept the displayed selection

[C2 1] Increment Type

Valid selections for increment type are 1, 2 or 5.

Press:

- 0** - Display next selection
- 1** - To accept the displayed selection

[C3] [1] Decimal Point Location

Valid decimal point selections are from 0.0000X to X00

Press:

- 0** - Display next selection
- 1** - To accept the displayed selection

[C4 0] Linearity Correction

The 8142 provides a calibration procedure to allow compensation of non-linearities in the weighing performance of the scale base. This procedure is not normally required and is provided for use only when the normal calibration procedure does not result in a linear response from the scale.

Press:

- 0 - Disable linearity compensation
- 1 - Enable linearity compensation

[C5] Overload Blanking Increments

The step allows entry of the maximum number of increments that will be displayed before the display will blank "overcapacity".

Note(S):

Any time a new scale capacity or increment size is selected, press the 0 key at the [C5] step to reset the overload blanking increments to the new capacity.

Press:

- 0 - Select default full capacity + 5 increments, overload blanking
- 1 - Access overload blanking increment entry
- ENTER** - Advance to next setup step without changing the overcapacity blanking selection

[5000] Enter Overload Blanking Increments

Enter the maximum number of increments that can be displayed before the display will blank. Press the ENTER key to accept entry.

[Shcut?] Access Short Cut Calibration

NOTE: Single display versions will skip short cut calibration, [Shcut?], and advance to empty scale, [E SCL].

Time, span and initial constants can be entered into the dual and dual display advanced versions instead of performing the normal calibration procedure if the 8142 has previously been calibrated using the normal calibration procedure. This step allows replacement of the Main PCB without requiring recalibration using test weights.

To print out the time, span and initial constants along with the rest of the setup parameters, connect a printer to the JN port. Press the SETUP key until the display shows [Print?], then press the 1 key. The calibration constants are printed at the end of the setup printout.

If a printer is not available the calibration constants can be read out by pressing 1 key when the display shows [Shcut?], and recording the constants for later use.

Press:

- 0 - To skip short cut calibration and advance to [E SCL] at beginning of the normal calibration procedure
- 1 - To view calibration constants and access short cut calibration

4.5.5. Calibration Procedure

Linearity compensation disabled and short cut calibration disabled uses the calibration procedure in section 4.5.5.1. This is the most commonly used procedure.

Linearity compensation enabled and short cut calibration disabled uses the calibration procedure in section 4.5.5.2. This procedure is only used to correct nonlinear weighing errors.

Short cut calibration uses the calibration procedure in section 4.5.5.3. This procedure is used only when a Main PCB is replaced and short cut calibration data was recorded from the original PCB.

4.5.5.1. Linearity Compensation and Short Cut Calibration Disabled

[E SCL] Empty Scale

Remove all weight from the scale base and press the **ENTER** key.

[15 CAL] Zero Count Down

The display will count down from 15 to 0 while the 8142 is recording zero.

[Add Ld] Add Load

Place test weights on the scale base. Ideally, the test weight used should be as close to scale capacity as possible. At a minimum, the test weights used should be at least 10% of scale capacity. Press the **ENTER** key to continue.

[] Enter Span Test Weight Value

The display will blank. Enter the value of the test weights used in whole units. No decimal point or fractions can be entered for test weight values. Press the **CLEAR** key to erase a test weight entry. Press the **ENTER** key to continue.

[15 CAL] Span Count Down

The display will count down from 15 to 0 while the 8142 is recording span.

[E SCL] Empty Scale

Remove all weight from the scale base and press the **ENTER** key.

[15 CAL] Zero Count Down

The display will count down from 15 to 0 while the 8142 is recording zero.

[CAL d] Calibration Done (Displayed Momentarily)

[CaL d] is displayed to indicate that the 8142 was calibrated successfully. Refer to Section 7 of this technical manual for suggested corrective action if an error code is displayed at this time.

After a few seconds the 8142 advances to the **[S File]** prompt which is described in Section 4.5.5.4.

4.5.5.2. Linearity Compensation Enabled, Short Cut Calibration Disabled

[E SCL] Empty Scale

Remove all weight from the scale base and press the **ENTER** key.

[15 CAL] Zero Count Down

The display will count down from 15 to 0 while the 8142 is recording zero.

[Add HI] Add Hi Load

Place test weights on the scale base. The test weights used must be as close to 100% of scale capacity as possible. Press the **ENTER** key to continue.

[] Enter High Span Test Weight Value

The display will blank. Enter the value of the test weights used in whole units. No decimal point or fractions can be entered for test weight values. Press the **CLEAR** key to erase a test weight entry. Press the **ENTER** key to continue.

[15 CAL] High Span Count Down

The display will count down from 15 to 0 while the 8142 is recording high span.

[Add LO] Add Low Load

Place test weights on the scale base. The test weights used must be as close to 50% of scale capacity as possible. Press the **ENTER** key to continue.

[] Enter Low Span Test Weight Value

The display will blank. Enter the value of the test weights used in whole units. No decimal point or fractions can be entered for test weight values. Press the **CLEAR** key to erase a test weight entry. Press the **ENTER** key to continue.

[15 CAL] Low Span Count Down

The display will count down from 15 to 0 while the 8142 is recording low span.

[E SCL] Empty Scale

Remove all weight from the scale base and press the **ENTER** key.

[15 CAL] Zero Count Down

The display will count down from 15 to 0 while the 8142 is recording zero.

[CAL d] Calibration Done (Displayed Momentarily)

[CaL d] is displayed to indicate that the 8142 was calibrated successfully. Refer to Section 7 of this technical manual for suggested corrective action if an error code is displayed at this time.

After a few seconds the 8142 advances to the **[S File]** prompt which is described in Section 4.5.5.4.

4.5.5.3. Short Cut Calibration

Notes: -Single display versions do not support short cut calibration.
-Short Cut calibration can only be used with same scale and indicator. You can not calibrate multiple scales with one indicators.

Enter the previously recorded calibration constants using the numeric keys on the keyboard. Press the **CLEAR** key to erase a calibration constant entry. Press the **ENTER** key to continue.

[t0] Time Zero Entry

Enter or record the time value obtained then press the **ENTER** key.

[t1] Time One Entry

Enter or record the time value obtained then press the **ENTER** key.

[FS Hi] Span High Entry

Enter or record the span high value obtained then press the **ENTER** key.

[FS LO] Span Low Entry

Enter or record the span low value obtained then press the **ENTER** key.

[F0 Hi] Zero High Entry

Enter or record the zero high value obtained then press the **ENTER** key.

[F0 LO] Zero Low Entry

Enter or record the zero low value obtained then press the **ENTER** key.

If linearity compensation is disabled, **[C4 0]**, then the calibration procedure will advance to **[S File]**, otherwise additional calibration constants will be displayed as described next.

[LF - 0] Linearity Compensation Direction

Enter or record the linearity compensation direction value obtained then press the **ENTER** key.

[LF Hi] Linearity Factor High

Enter or record the linearity factor high value obtained then press the **ENTER** key.

[LF LO] Linearity Factor Low

Enter or record the linearity factor low value obtained then press the **ENTER** key.

[SP Hi] Linearity Span Factor High

Enter or record the linearity span factor high value obtained then press the **ENTER** key.

[SP LO] Linearity Span Factor Low

Enter or record the linearity span factor low value obtained then press the **ENTER** key.

4.5.5.4. Save Setup and Calibration Data

[S FILE] Save File?

The step allows setup changes and calibration to be saved to nonvolatile memory (NOVRAM). If not saved, changes made are lost when AC power is removed.

Press:

- 0** - Do not save changes to NOVRAM
- 1** - Save changes to NOVRAM

[J2 On?] Jumper 2 On?

The 8142 requires that the setup jumper be removed before setup can be exited. Remove the jumper from W2 and press the **ENTER** key to exit setup. Leave W2 OFF to prevent inadvertent changes to setup.

4.5.6. Span Adjust

This step allows an adjustment to span without repeating the entire calibration procedure. This is especially useful on large capacity, tank and hopper scales where a build-up calibration procedure is used for calibration. The procedure for using the using span adjust is as described next.

The span adjust procedure will work correctly in the net mode once only. After a net span adjust has been made the previous tare must be cleared and a new tare weight must be taken before the span adjust can be repeated.

Apply a load of known weight to the scale, compare the weight reading with the known weight. If errors are noted proceed with the span adjust procedure.

Note: The normal calibration procedure, as specified in section 4.5.5. **MUST** be performed at least once before the span adjust procedure can be used.

4.5.6.1. Enable Span Adjust, Setup Step [F3.5 1]

Install the setup jumper (W2) and enter the setup mode as described in section 4.5.2. Step through the setup until step **[F3.5]** is displayed and press the **1** key. Exit the setup mode by pressing the **SETUP** key, when the display shows **[S File]** press the **1** key. Remove (W2) and press the **ENTER** key. The display will return to the normal weight display mode.

4.5.6.2. Access Span Adjust [CAL AJ]

Install the setup jumper (W2) and enter the press the **SETUP** key. **[CAL AJ]** is now displayed with the cursors flashing slowly. On the dual and dual display advanced versions the weight display will continue to show net or gross weight.

With the display showing **[CAL AJ]** press the **1** key to access span adjust. If the **0** key is pressed the setup mode will be accessed. If any other key is pressed the 8142 will abort span adjust and return to the normal weighing mode.

After pressing the **1** key, the display will blank, the cursors will be flashing slowly and the decimal point will be lit.

Enter the correct value for the load on the scale. The entire weight value including digits to the right of the decimal point **MUST** be entered using the numeric keys on the keyboard, followed by the **ENTER** key.

The weight display should now show the correct weight value for the load on the scale. The span adjust procedure can be entered repeatedly into the 8142 as needed during a build-up test procedure.

After all span adjustments are completed, disable span adjustment. Install the setup jumper (W2) and enter the setup mode as described in section 4.5.3. Step through the setup until step **[F3.5]** is displayed and press the **0** key. Exit the setup mode by pressing the **SETUP** key, when the display shows **[S File]** press the **1** key. Remove (W2) and press the **ENTER** key. The display will return to the normal weight display mode.

4.6. Sealing The NEMA 4X Wall Mount Enclosure

A small tube of sealant (*118251 00A) is included with each stainless steel wall mount enclosure version of the 8142. This sealant **MUST** be applied to the cover gasket before final closure of the wall mount enclosure to ensure a water tight seal. Follow the procedure listed next to correctly apply the sealant.

Clean the gasket, located on the inside of the door of the enclosure, with a clean cloth to remove any debris.

Apply an even bead of sealant to the gasket.

Smooth out the sealant with your finger so it is applied in an even, thin coat completely covering the gasket.

After closing and properly tightening the door, wipe off any excess sealant.

5. OPERATING INSTRUCTIONS

5.1. DISPLAY(S) DESCRIPTION

The displays are blue-green, vacuum fluorescent, six character digits or 5 digits and a minus sign with a lighted decimal point. All digits are 0.5 inches (1.3 cm) in height. Overcapacity is indicated by blanking of the display, as selected by step **[C5]** overcapacity blanking. Under zero is indicated by blanking the display with a minus sign, as selected by step **[F3.6]** extended under zero display. Motion is indicated by extinguishing the lb or kg cursor. On dual display versions, the upper display indicates either gross weight or net weight if tare is entered. The auxiliary display can show tare weight, time, date, ID, or consecutive number. Setpoints may also be displayed on the auxiliary display on the dual display-advanced 8142. Refer to Figures 5-1, 5-2 and 5-3 for display examples.

If a negative six digit net weight occurs, the display will alternately show the weight value then six minus signs. The correct weight will be transmitted out the JN port.

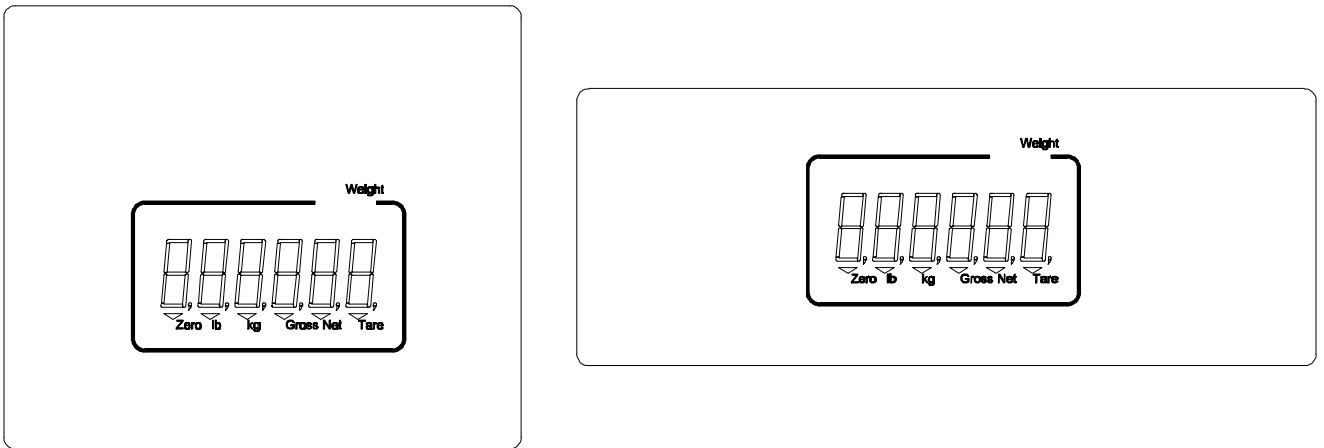

Figure 5-1: Single Display Desk/Wall and Rack Version Displays

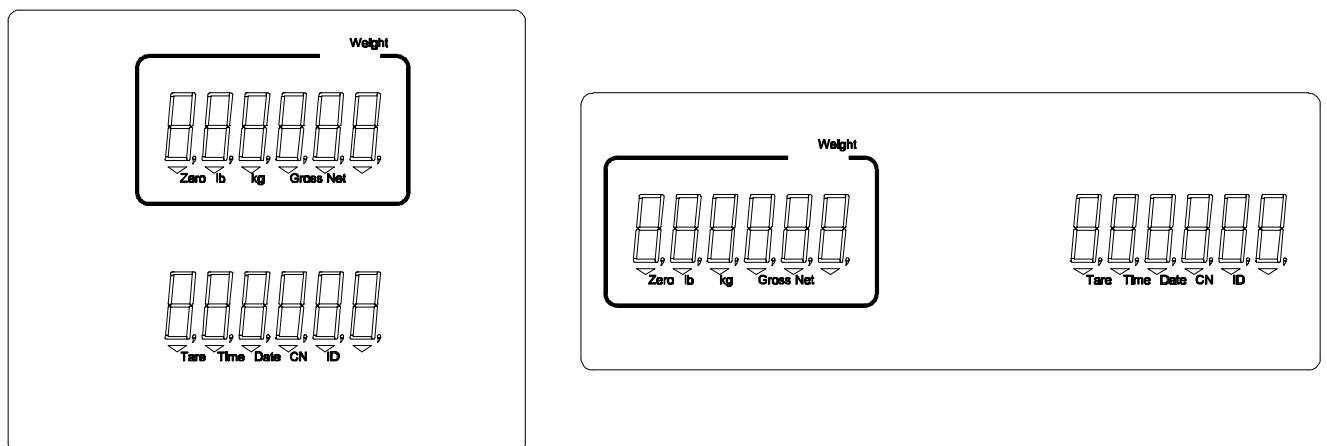

Figure 5-2: Dual Display Desk/Wall and Rack Version Displays

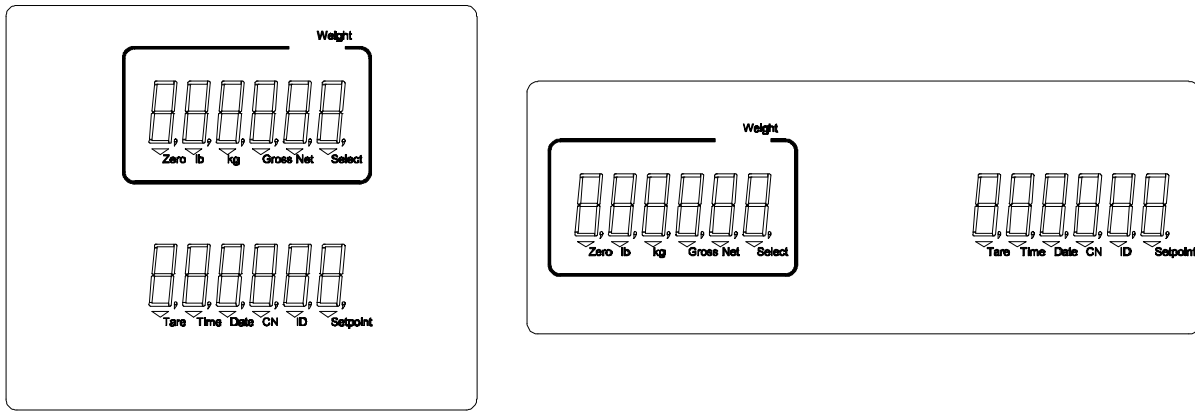

Figure 5-3: Dual Display Advanced Desk/Wall and Rack Version Displays

5.2. DISPLAY CURSORS

The legends are indicated by lighted cursors directly above legends printed on the display lens.

- lb - The lb cursor indicates that pound units have been selected and the scale is in a "no motion" condition.
- kg - The kg cursor indicates that kilogram units have been selected and the scale is in a "no motion" condition.
- Zero - The Zero cursor indicates that the displayed weight is within ± 0.25 increments of gross zero. If net zero cursor is enabled the Zero cursor will also indicate that the displayed weight is within ± 0.25 increments of net zero.
- Net - The Net cursor indicates that a net weight is displayed and a tare has been entered.
- Gross - The Gross cursor indicates that a gross weight is displayed no tare has been entered.
- Tare - The Tare cursor indicates that a tare weight is being displayed on either the weight display (single display versions) or the auxiliary display (dual and dual display advanced versions).
- Time - The Time cursor indicates that the auxiliary display is showing time, (dual and dual display advanced versions).
- Date - The Date cursor indicates that the auxiliary display is showing the date, (dual and dual display advanced versions).
- CN - The CN cursor indicates that the auxiliary display is showing the consecutive number, (dual and dual display advanced versions).
- ID - The ID cursor indicates that the auxiliary display is showing the numeric ID, (dual and dual display advanced versions).
- Setpoint - The Setpoint cursor indicates that the auxiliary display is showing a setpoint variable, (dual display advanced versions).
- Select - The Select cursor is illuminated in conjunction with the Setpoint cursor to indicate a setpoint description (SP-1, etc.) is being shown on the weight display, (dual display advanced versions).

5.3. KEYBOARD DESCRIPTIONS

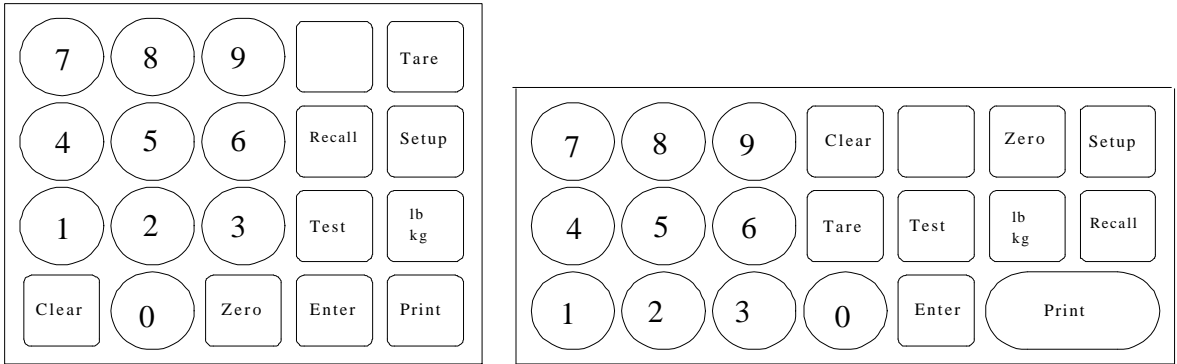

Figure 5-4: Single Display, Desk/Wall and Rack Version Keyboards

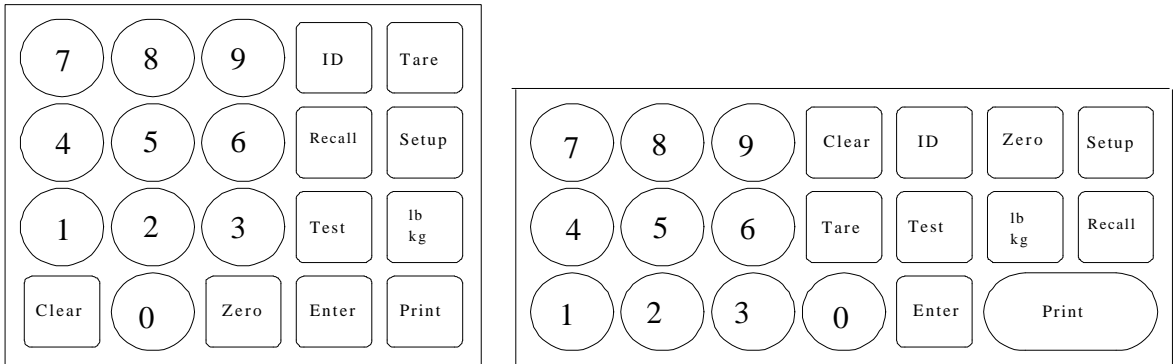

Figure 5-5: Dual Display, Desk/Wall and Rack Version Keyboards

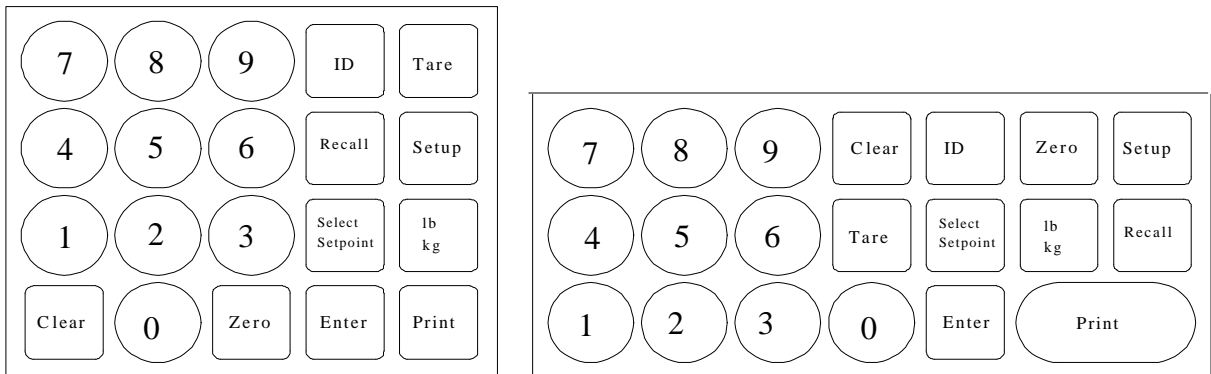

Figure 5-6: Dual Display Advanced, Desk/Wall and Rack Version Keyboards

- Numeric Digits (0-9) - Used to enter numeric data when required as in keyboard tare, ID, time, date, etc. Corresponding digits are echoed on the display.
- ZERO - Provides the ability to re-zero the scale over a range of $\pm 2\%$ or $\pm 20\%$ of the programmed full scale capacity. The function of this pushbutton may be disabled in setup mode.
- CLEAR - Used to clear tare weight (returns indicator to "gross mode"), ID, consecutive number, time, date and setpoint values. The clear function can be selected to automatically. If the CLEAR key is pressed twice a display test sequence occurs with the dual display advanced versions when in the gross weight mode.
- TARE - When the TARE KEY is pressed with weight on the scale, and the scale is in a "no motion" condition, the weight on the scale will be stored as a tare weight and subtracted from the gross weight to provide a net weight display of zero. If the weight is removed from the scale, the net weight will be displayed as a negative value.

A tare weight can be manually entered by means of the numeric keys on the keypad. Keyboard tare weights of up to full scale capacity can be entered. The least significant digit (LSD) of a keyboard tare entry must correspond to the displayed increment size or else the keyboard tare entry will not be accepted. If tare interlocks are enabled, keyboard tare may only be entered with the scale at gross zero.

The 8142 can be placed into the net weight mode using the previously entered tare weight, by pressing the Enter key followed by the Tare key within 2 seconds of the first keystroke with the 8142 in the gross weight mode. If more than 2 seconds lapse between keystrokes of the Enter and Tare key, a normal pushbutton tare will be taken.
- PRINT - The PRINT key initiates a data output cycle. Data output format and baud rate are selectable in setup mode. In addition, on dual display models only, data output increments the consecutive number stored in memory. Please refer to Section 6.4 for data output details.
- lb
Ä
kg - An alternate action pushbutton is provided for pound/kilogram units selection. When switching the increment size will be adjusted and decimal point is moved if necessary. Units switching can be inhibited and the 8142 selected to power-up in either unit. Units switching from lb to kg switches to the nearest kg equivalent and the same is true in reverse for kg to lb switching. For example: 1 lb increment size converts to 0.5 kg, 2 lb increment size converts to 1 kg, 5 lb increment size converts to 2 kg, etc.
- ENTER - The ENTER key is used to terminate numeric data entry for consecutive number, time, date and setpoints. Also, the ENTER key may be used preceding the TARE key to reuse the previous tare weight and return the indicator to the net mode. The ENTER key is also used during setup.
- ID - The ID key is used in conjunction with the numeric keys (0-9) to allow the operator to enter up to six digits of numeric ID. Depression of the ID key causes the current ID number to be displayed on the auxiliary display and the ID cursor to be illuminated. At this time the operator may input a new ID or, press ENTER key and accept the present ID. In either case, pressing the ENTER or ID key terminates the sequence and returns the auxiliary display to its previously selected display mode (via the RECALL key).
- RECALL - The RECALL key is used to review numeric data in memory, the data entries cannot be changed in the recall mode. To enter new data for the variables displayed, refer to the SETUP key discussion following.

Single display versions: Depression of the RECALL key will display the tare value stored in memory for 2 seconds and then return to the normal weight display mode.

Dual display and dual display advanced versions: Sequential depressions of the RECALL key will display tare weight, time, date, consecutive number, ID and setpoint values (dual display

advanced only, if setpoints enabled). Corresponding cursors are illuminated for each value displayed. Cursors and the auxiliary display can be blanked after all data has been examined, or the operator may choose any of the recall selections to be continuously displayed on the auxiliary display except when the auxiliary display is being used for displaying tare weight.

TEST - The TEST key is used to initiate a display test sequence. The operator should visually note that all segments of each digit are correctly illuminated during the test. Dual display advanced versions use a double depression of the CLEAR key to access the display test sequence.

SETUP - Single display versions: The SETUP key is used to access the scale setup mode. This function may be inhibited via an internal hardware jumper.

Dual display and dual display advanced versions: The first depression of the SETUP key causes the current consecutive number (CN) to be displayed on the auxiliary display and the CN cursor to be illuminated. At this time the operator may input a new consecutive number, reset to zero, or accept the present value. In either case, depression of the ENTER key terminates the sequence and returns the auxiliary display to the previously selected display mode.

If the SETUP key is depressed while the consecutive number is being displayed, the display will advance to the time entry step of the setup mode. Refer to Section 4.5.3. for details.

SELECT SETPOINT - The Dual Display Advanced versions contain 4 separate programmable setpoint outputs which can be configured in setup as either 2 groups of dual speed setpoints or as 4 single speed setpoints.

When the outputs are configured as single speed, each output will require a setpoint value entered as an "absolute weight value". No weight tolerance outputs are available, the zero tolerance outputs are the only active tolerance outputs in this configuration.

When the outputs are configured as dual speed outputs, a setpoint, dribble, preact and tolerance value can be entered for each setpoint.

When the SELECT SETPOINT key is depressed, the Select and Setpoint cursors are both illuminated. During the setpoint data entry procedure up to six digits of new setpoint data is entered by means of the numeric keys on the keyboard. Use the setpoint data entry sequences listed next: either the 4 setpoint mode or the 2 setpoint mode.

5.4. SETPOINT DATA ENTRY

Setpoint data entry sequences:

P[] indicates the primary weight display.
A[] indicates the auxiliary display.
old val indicates the old or current value stored in memory.

During the setpoint data entry Press:

ENTER - To accept the displayed setpoint data and advance to the next setpoint entry step.

SELECT SETPOINT - To accept the displayed setpoint data and exit setpoint entry.

5.4.1. Data Entry for 4 Setpoint Mode

The following is the entry sequence when the indicator is configured for 4 single speed setpoints, [F7.2 4].

P[SP-1] - Enter setpoint 1 value.

- A[oldval] - Enter a new value for setpoint 1, or press the ENTER key to advance to [SP-2].
- P[SP-2] - Enter setpoint 2 value.
- A[oldval] - Enter a new value for setpoint 2, or press the ENTER key to advance to [SP-3].
- P[SP-3] - Enter setpoint 3 value.
- A[oldval] - Enter a new value for setpoint 3, or press the ENTER key to advance to [SP-4].
- P[SP-4] - Enter setpoint 4 value.
- A[oldval] - Enter a new value for setpoint 4, or press the ENTER key to advance to [Otol-1].
- P[Otol-1] - Enter zero tolerance 1 value, (only if enabled during setup).
- A[oldval] - Enter a new value for zero tolerance, or press the ENTER key to advance to [Otol-2].
- P[Otol-2] - Enter zero tolerance 2 value, (only if enabled during setup).
- A[oldval] - Enter a new value for zero tolerance, or press the ENTER key to exit setpoint entry.

5.4.2. Data Entry for 2 Setpoint Mode

The following entry sequence is used when the 8142 is configured for 2, dual speed setpoints.

- P[SP-1] - Enter setpoint 1 value.
- A[oldval] - Enter a new value for setpoint 1, or press the ENTER key to advance to [dr-1].
- P[dr-1] - Enter dribble 1 value.
- A[oldval] - Enter a new value for dribble 1, or press the ENTER key to advance to [Pr-1].
- P[Pr-1] - Enter preact 1 value.
- A[oldval] - Enter a new value for preact 1, or press the ENTER key to advance to [tol-1].
- P[tol-1] - Enter tolerance 1 value.
- or P[Otol-1] - Enter zero tolerance 1 value if zero tolerance mode is selected.
- A[oldval] - Enter a new value for tolerance 1, or press the ENTER key to advance to [tol-2].
- P[SP-2] - Enter setpoint 2 value.
- A[oldval] - Enter a new value for setpoint 2, or press the ENTER key to advance to [dr-2].
- P[dr-2] - Enter dribble 2 value.
- A[oldval] - Enter a new value for dribble 2, or press the ENTER key to advance to [Pr-2].
- P[Pr-2] - Enter preact 2 value.
- A[oldval] - Enter a new value for preact 2, or press the ENTER key to advance to [tol-2].
- P[tol-2] - Enter tolerance 2 value.

- or P[0tol-2] - Enter zero tolerance 2 value if zero tolerance mode is selected.
- A[oldval] - Enter a new value for tolerance 2, or press the ENTER key to exit setpoint setup.

Note: If **[SP Err]** is displayed during operation then the setpoint data is corrupt and must be reentered. The 8142 will not proceed until valid setpoint data has been entered by the operator. Refer to Section 7. for details about error codes.

5.5. POWER-UP SEQUENCE

When power is first applied, the 8142 performs internal checks on the RAM, ROM and NOVRAM. The display(s) are verified by sequentially displaying all possible numbers from all zeros through all nines. The display(s) then blank and all decimal points and cursors are illuminated. The program part number **[128901]** is displayed next followed by the program revision level **[3]**.

If the power-up timer is enabled, **[F3.1 1]**, then the display will blank and all six cursors on the weight display will blink for thirty seconds. If tare interlocks are enabled, step **[F2.2 1]**, then the weight display will indicate **[E E E]** (for above zero weights) or **[-E E E]** (for below zero weights) until zero is captured (either by the AZM function or by pressing the ZERO key). If tare interlocks are disabled, the weight mode (Gross or Net) that was in use at the time of power loss will be displayed.

6. HARDWARE SETUP

6.1. PCB CONNECTORS AND JUMPERS

6.1.1. Single Display/Main PCB

The Main PCB is present in all versions of the 8142. The rack mount Single display version does not have a display tube installed on the Main PCB. In Dual and Dual Display Advanced versions the Main PCB is located behind or under the Dual Display PCB and does not have a display tube installed.

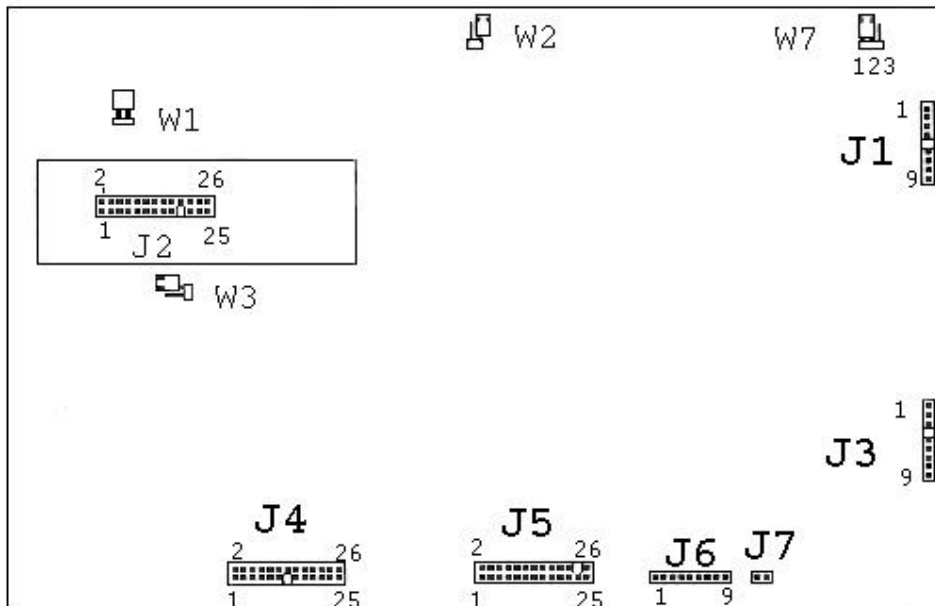

Figure 6-1: Main PCB

6.1.1.1. Main PCB Connectors

J1-Load Cell Connector

J2-Display Data Connector (for Rack Versions Only)

J3-AC Transformer Input Connector

J4-Data Bus Connector (for Dual and Dual Display Advanced Versions only)

J5-JN Port Serial I/O Connector

J6-Keyboard Connector

J7-Tool Operated Pushbutton Zero Input

6.1.1.2. Main PCB Jumpers

W1 - ROM Enable: Must be (IN)

W2 - Calibration Enable: (OUT) For single display versions. Place the W2 jumper (IN) to access the setup mode. Remove the W2 jumper to exit setup.

W2 - Dual and Dual Display Advanced Versions W2 is connected to W8 on the Display PCB by a cable assembly.

W3 - Comma Select: (OUT) Place the jumper (IN) to display a comma in place of the decimal point.

W7 - mV/V Selection: (1-2)

- (1-2) 2 mV/V load cell input.

- (2-3) 3 mV/V load cell input.

6.1.2. Dual And Dual Display Advanced PCB

The Dual Display PCB is present in Dual and Dual Display Advanced version 8142 only. In rack mount versions the Dual Display PCB does not have the display tubes installed.

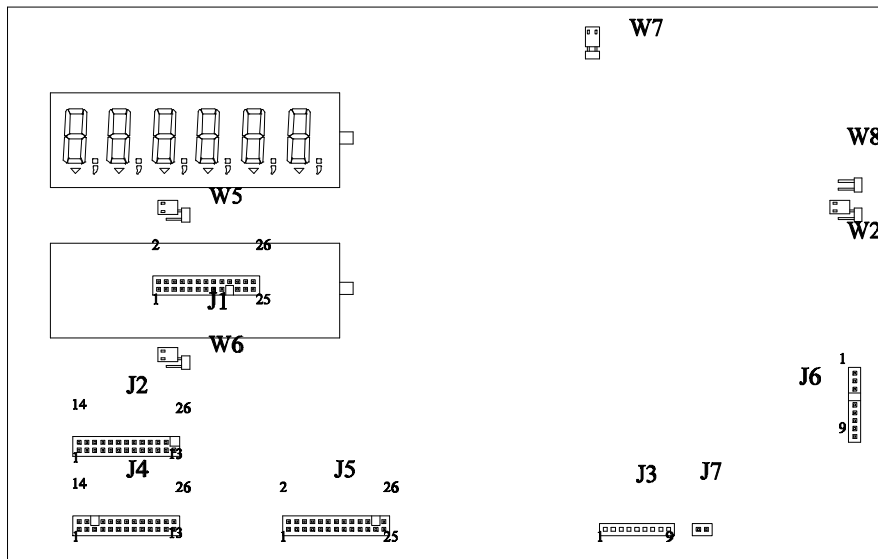

Figure 6-2: Dual Display PCB

6.1.2.1. Dual Display PCB Connectors

- J1-Display Connector for Rack Enclosures**
- J2-JW Setpoint Port Connector**
- J3-Keyboard Connector**
- J4-JY Host Interface Connector**
- J5-Data Bus Connector (From Main PCB)**
- J6-AC Transformer Input Connector**
- J7-Tool Operated Pushbutton Zero Input**

6.1.2.2. Dual Display PCB Jumpers

- W2-Calibration Enable: (OUT)** Place the W2 jumper (IN) to access the setup mode. Remove the W2 jumper to exit setup.
- W5-Primary Display Comma Select: (OUT)** Place the W5 jumper (IN) to display a comma in place of the decimal point in the primary weight display.
- W6-Auxiliary Display Comma Select: (OUT)** Place the jumper (IN) to display a comma in place of the decimal point in the auxiliary data display.
- W7-ROM Enable: Must be (IN)**
- W8-Extension of W2 from the Main PCB** A harness plugs onto this jumper from W2 on the Main PCB to allow W2 on the Dual Display PCB to access setup.

6.1.3. Display PCB (Rack Versions Only)

The rack mount Single Display 8142 has a Display PCB with 1 display tube installed. The rack mount Dual and Dual Display Advanced 8142 has a Display PCB with 2 display tubes installed.

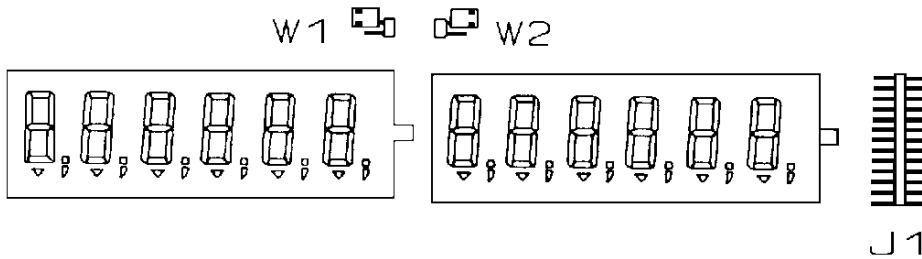

Figure 6-3: Display PCB (Rack Versions Only)

6.1.3.1. Rack Display PCB Connector

J1 - Data Connector

6.1.3.2. Rack Display PCB Jumpers

- W1 - Primary Display Comma Select: (OUT)** Place the W5 jumper (IN) to display a comma in place of the decimal point in the primary weight display.
- W2 - Auxiliary Display Comma Select: (OUT)** Place the jumper (IN) to display a comma in place of the decimal point in the auxiliary data display.

6.1.4. Optional BCD/Analog PCB (Dual Display Advanced Rack and Wall Enclosures Only)

The BCD/Analog option can be used with the Dual Display Advanced, Rack and Wall enclosure versions only. The Single and Dual display versions do not support the BCD/Analog option. There is insufficient room for the BCD/Analog option to be installed inside the Dual Display Advanced, Desk enclosure.

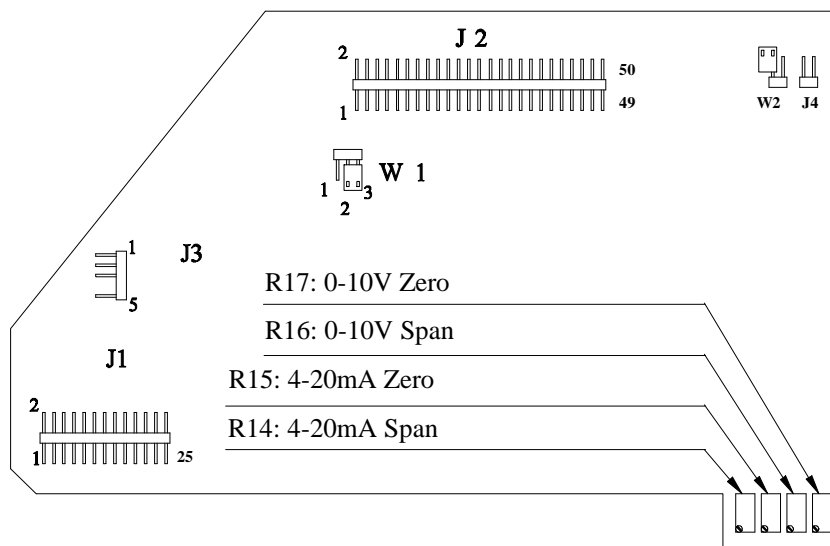

Figure 6-4: BCD/Analog PCB

6.1.4.1. BCD/Analog PCB Connectors

- J1 - Data Bus Connector**
- J2 - BCD/Analog Output Connector**
- J3 - +10 VDC Power Input Connector**
- J4 - Setup Jumper Extension Connector** Rack mount enclosure only, a harness plugs onto this jumper from W2 on the Main PCB to allow W2 on the BCD/Analog PCB to access setup.

6.1.4.2. BCD/Analog PCB Jumpers

- W1 - Motion Detect Inhibit: (2-3)**
 - **(1-2)** The sync pulse output (a high to low pulse) occurs at the end of every A/D update even when the scale is "in motion". The motion sync inhibit input (Connector J2, pin 50) has no effect.
 - **(2-3)** The sync pulse output occurs at the end of every A/D update except when the scale is "in motion". BCD outputs will not update until the 8142 is a no motion condition. Grounding pin 50 of the J2 Connector (BCD/Analog Output) will disable the motion detect control of the sync pulse output.
- W2 - Calibration Enable: (OUT)** Place the W2 jumper (IN) to access the setup mode. Remove the W2 jumper to exit setup. (Used on rack versions only).

6.2. ENCLOSURE CONNECTOR LOCATIONS

6.2.1. Desk Enclosure (Rear View)

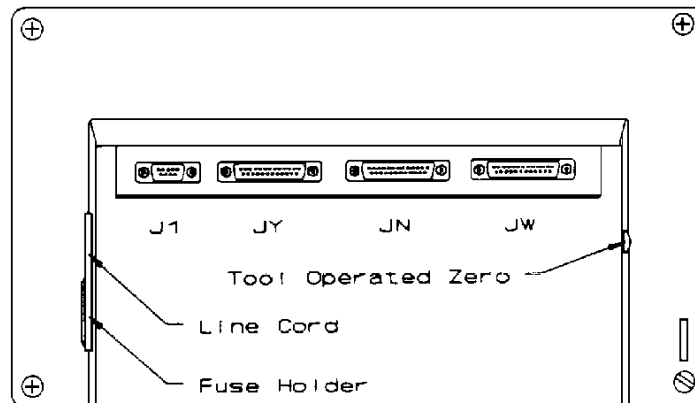

Figure 6-5: Desk Enclosure (Rear View)

- J1 - Load Cell**
- JY - Optional Host Interface Port**
- JN - Printer Port**
- JW - Setpoint Port (Standard on Dual Display Advanced version only)**

6.2.2. Wall Enclosure (Bottom View)

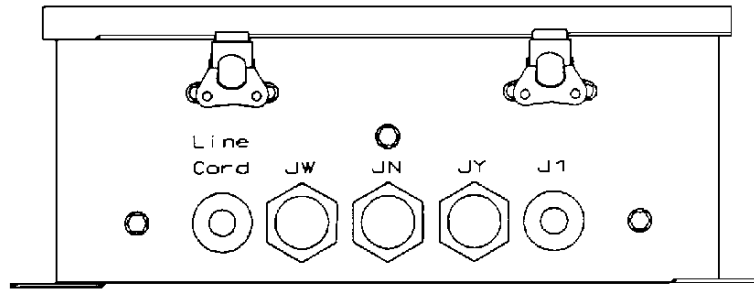

Figure 6-6: Wall Enclosure (Bottom View)

- JW- Setpoint Port (Standard on Dual Display Advanced only)**
- JN- Printer Port**
- JY- Optional Host Interface Port**
- J1 - Load Cell**

6.2.3. Rack Enclosure (Rear View)

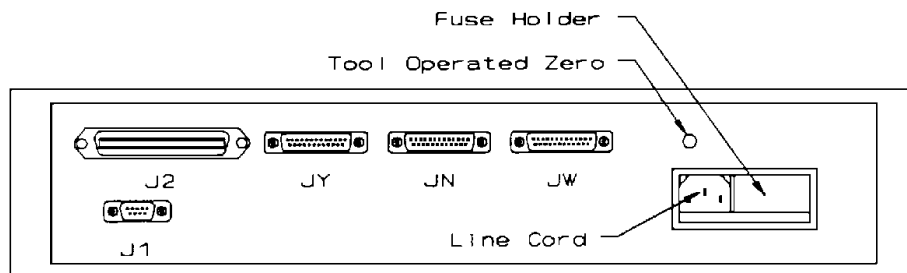

Figure 6-7: Rack Enclosure (Rear View)

- J1 - Load Cell**
- J2 - Optional BCD/Analog**
- JY- Optional Host Interface Port**
- JN- Printer Port**
- JW- Setpoint Port (Standard on Dual Display Advanced only)**

6.3. Load Cell Interconnect

Before any load cell connections are made, the type of load cell to be connected must be determined. The Model 8142 is designed to be used with **ANALOG LOAD CELLS ONLY**.



The recommended load cell cable for use with the Model 8142 is a 20 gauge, 6 conductor, shielded cable, Toledo part number (510620370). This cable is ordered by the foot. The recommend maximum length for the 20 gauge cable is 300 ft. Refer to Section 6.3.1. for desk or rack enclosure load cell cable termination and refer to Section 6.3.2. for wall enclosure load cell cable termination.

6.3.1. J1 Connector Load Cell Cable Termination for Desk and Rack Enclosure Versions

Desk and Rack enclosure versions utilize a female 9 pin, DE-9 connector for load cell interconnect. Terminate the load cell cable to the mating, DE-9 connector (117599 00C) and connector shell (125384 00A) included with the 8142. Refer to Table 6-1 for connector wiring instructions. The DE-9 mating connector, pin 6 has been removed to match the key plug in pin 6 of the J1 connector on the 8142. Refer to Figure 6-8 for connector pinout.

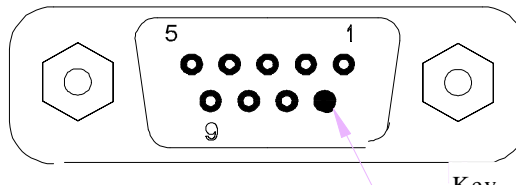

Figure 6-8: J1 Load Cell Connector, Desk and Rack Versions

Desk/Rack Enclosure J1 Connector	Function	Load Cell Termination			
		6 Wire Cable		4 Wire Cable	Jumpers
		Wire Color	Pin	Wire Color	
1	+Excitation	White	A	Green	AA ₂ AA _U
2	+Sense	Yellow	D	Jumper	
3	Shield	Orange		Yellow	AA ₂ AA _U
4	-Sense	Red	F	Jumper	
5	-Excitation	Blue	C	Black	
6	Key	Not Used		Not used	
7	+Signal	Green	E	White	
8	-Signal	Black	B	Red	

Table 6-1: J1 Load Cell Connector Pinout for Desk and Rack Enclosure Versions

Note(S):

Toledo® home run cable (part number 510620370) uses the same color code as 6 wire load cells.

When using a Model 951 load cell in tension, reverse the signal wires from that which is shown in Tables 6-1 and 6-2, (e.g. +Signal is red and -Signal is white).

Load cell pin letters shown are for load cells that use the female 6 pin round connector. Jumpers shown are located inside the load cell.

When connecting a four wire load cell to the 8142, always jumper the +Excitation to the +Sense and jumper the -Excitation to the -Sense at the junction closest to the load cell.

If cable lengths greater than 300 ft are required, then use a 16 gauge, 6 conductor shielded cable, (51061370). This cable is ordered by the foot. The recommended maximum length for the 16 gauge cable is 1000 ft.

Desk and rack versions only: The 16 gauge load cell cable used for home cable runs longer than 300 ft is too large to terminate properly with the DE-9 connector used by the desk and rack versions. The older style, round 7 pin connector (117661 00A) and connector clamp (117662 00A) must be used to terminate the 16 gauge cable. Refer to Table 6-2 and Figure 6-9 for termination data for the older style round 7 pin style connector. An adapter cable (part number 117611 00A) is then used to convert the older style round 7 pin connector to the DE-9 connector used with the desk and rack versions.

Pin	Description	Wire Color
A	+Signal	Green
B	-Signal	Black
C	+Excitation	White
D	-Excitation	Blue
E	+Sense	Yellow
F	-Sense	Red
G	Shield	Orange

Table 6-2: Older Style Round 7 Pin Load Cell Connector Termination
 (*) Color codes valid with Toledo® cable 510620370

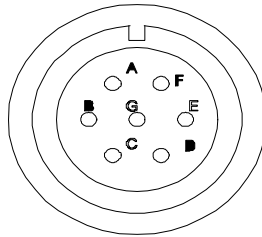

Figure 6-9: Round 7 Pin Connector Pinout

6.3.2. Wall Enclosure

Wall enclosure versions use a terminal strip assembly to terminate the load cell cable. Remove the J1 load cell termination assembly from the bottom of the enclosure to access the terminal strip. Refer to Figure 6-10 for load cell termination assembly location.

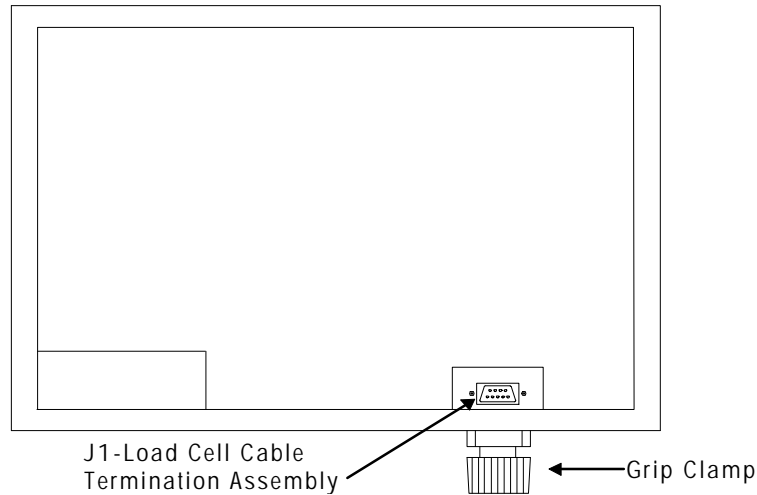

Figure 6-10: Wall Enclosure, Load Cell Termination Assembly

Insert the load cell cable into the wall enclosure through the cable grip clamp located on the bottom right side of the enclosure. Terminate the load cell cable to the terminal strip located inside the load cell termination assembly. Refer to Figures 6-10, 6-11 and Table 6-3.

Wall Enclosure J1		Function	Load Cell Termination			
Old Style Twist Lock Connector	New Style Terminal Strip		6 Wire Cable		4 Wire Cable	Jumpers
			Wire Color	Pin	Wire Color	
C	+EXC	+Excitation	White	A	Green	AA AAU
E	+SEN	+Sense	Yellow	D	Jumper	
Shell	Stud	Shield	Orange		Yellow	AA AAU
F	-SEN	-Sense	Red	F	Jumper	
D	-EXC	-Excitation	Blue	C	Black	
A	+SIG	+Signal	Green	E	White	
B	-SIG	-Signal	Black	B	Red	

Table 6-3: J1 Load Cell Connector Pinout for Wall Mount Enclosure Versions

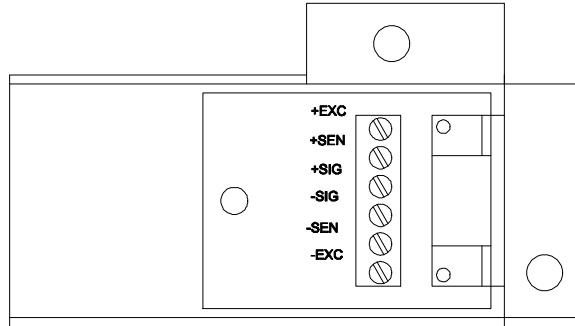

Figure 6-11: Load Cell Termination Assembly

Note(s):

- Toledo® home run cable (part number 510620370) uses the same color code as 6 wire load cells.
- When using a Model 951 load cell in tension, reverse the signal wires from that which is shown in Tables 6-1 and 6-2, (e.g. +Signal is red and -Signal is white).
- Load cell pin letters shown are for load cells that use the female 6 pin round connector. Jumpers shown are located inside the load cell.
- When connecting a four wire load cell to the 8142, always jumper the +Excitation to the +Sense and jumper the -Excitation to the -Sense at the junction closest to the load cell.
- If cable lengths greater than 300 ft are required, then use a 16 gauge, 6 conductor shielded cable, (51061370). This cable is ordered by the foot. The recommended maximum length for the 16 gauge cable is 1000 ft.

6.3.3. Junction Box Connections

6.3.3.1. Floor Scale (Model 2157)

The 8142 is compatible with the Model 2157 Floor scale with the ANALOG junction box Option ONLY! **The DigiTOL® Power Module IS NOT compatible with the 8142 indicator.**

Terminal strip TB1 on the J-Box PCB is the output terminal strip of the floor scale to the 8142. Refer to Figure 6-12 and Table 6-4 for TB1 termination data. Terminal strips TB2 and TB3 are for the load cell connections. Refer to Figure 6-12 and Table 6-3 for load cell cable termination. Refer to Section 6.3.2. for load cell cable color codes.

TB1		TB2		TB3	
Pin	Description	Pin	Description	Pin	Description
1	+Signal	1	-Signal L/C 2	1	-Signal L/C 1
2	-Signal	2	+Signal L/C 2	2	+Signal L/C 1
3	Shield	3	-Signal L/C 4	3	-Signal L/C 3
4	+Sense	4	+Signal L/C 4	4	+Signal L/C 3
5	-Sense	5 *	Shield	5 *	Shield
6	-Excitation	6 **	+Excitation L/C 2 & 4	6 **	+Excitation L/C 1 & 3
7	+Excitation	7 **	-Excitation L/C 2 & 4	7 **	-Excitation L/C 1 & 3

Table 6-4: Floor Scale J-Box PCB Termination. TB1, TB2 and TB3

Notes: Floor Scale table, load cells are referred to as L/C.

- (*) - A load cell shield connection is not required when all load cells are contained within one steel understructure.
- (**) - Terminals 6 and 7 will each have two wires connected. One wire from pin 6 and one wire from pin 7 will go to each load cell supplied.

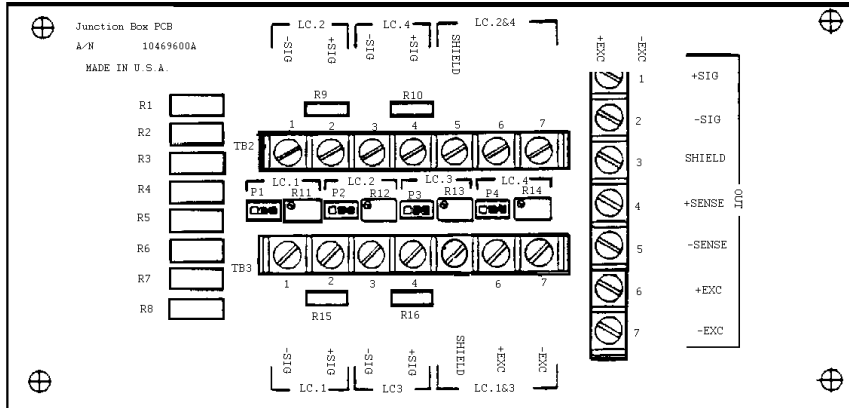

Figure 6-12: Floor Scale J-Box PCB

6.3.3.2. Vehicle Style Junction Box

The 8142 is compatible with ANALOG load cell truck scales ONLY! **The DigiTOL® TRUCKMATE IS NOT compatible with the 8142 indicator.**

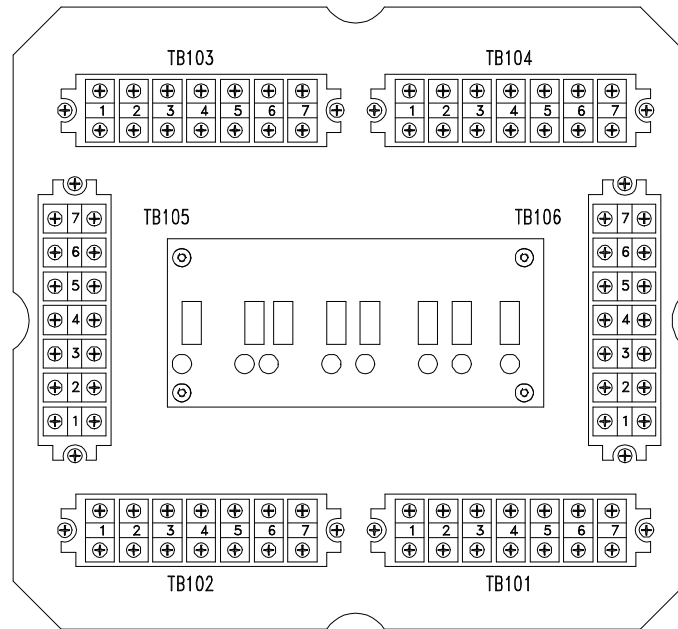

Figure 6-13: Vehicle Style J-Box PCB

TB105 provides an input terminal strip for another junction box output to be connected to if multiple junction boxes are required.

TB106 is the output terminal strip to the 8142.

All terminal strips TB101 through TB106 use the same wiring with vehicle style J-Boxes. Refer to Figure 6-13 and Table 6-5 for termination data. Refer to Section 6.3.2. for load cell cable color codes.

Terminal	Signal Description
1	+Signal
2	-Signal
3	Shield
4	-Excitation
5	+Excitation
6 *	+Sense
7 *	-Sense

Table 6-5: Vehicle Style J-Box Termination

NOTE:

(*) If four wire load cells (no sense leads) are used, there must be two jumpers installed on TB101. The two jumpers must be placed from terminal 4 to terminal 7 and from terminal 5 to terminal 6. These jumpers are not required with 6 wire cells. If four wire load cells are used, no wires will be connected to terminals 6 and 7 on TB102, TB103 and TB104.

6.4. JN Printer Port

The 8142 JN port supplies 20 mA current loop, RS-232C and RS-422 (two wire, half duplex) interfaces for input and output of serial data in 4 different modes of operation. The data format used by the JN port is a 10 bit ASCII frame which consists of: 1 start bit, 7 data bits, 1 even parity bit and 1 stop bit. A selectable checksum character is provided to ensure the integrity of the transmitted data.

Data is simultaneously output through all 3 of the interfaces provided and any combination of the outputs can be used (e.g. the 20 Ma output connected to a ticket printer and the RS-232C output connected to a computer).

The 20 mA current loop input or the RS-232C DSR (Data Set Ready) line can be used as a remote print input in a "pulse" mode, if Remote ASCII Input is disabled [**F5.17 0**].

Single ASCII command characters can be received to perform clear to gross, autotare, print and zero functions, if Remote ASCII Input is enabled [**F5.17 1**] or [**F5.17 2**].

Refer to Table 6-6 and Figures 6-14 and 6-15 for JN Port interconnect information. Refer to Section 8.2. for a list of available printer interface cables and mating connectors.

6.4.1. JN Port Printer Interconnect

8142 JN		Signal Description	301/ 307	8806/ 8860 Desk	8860 Wash Down	8843	8855
Desk/Rack	Wall						
1	A	Chassis GND					
2	B	TxD RS-232C				3	
3	C	RxD RS-232C					
4	D	RTS RS-232C					
5	E	CTS RS-232C					
6	F	DSR RS-232C					
7	G	Logic GND				7	
8	H	+RxD 20 mA		11			
9	J	-TxD 20 mA	6	16	H		3
10	K	-RxD 20 mA		22			
11	L	RS-422 A					
12	M	RS-422 B					
13	N	Not Used					
14	P	+Txd 20 mA					
15	R	+22 VDC					
16	S	+RxD 20 mA					
17	T	-22 VDC					
18	U	-RxD 20 mA					
19	V	Logic GND					
20	W	DTR RS-232C					
21	X	-22 VDC					
22	Y	Logic GND	7	18	K		22
23	Z	Logic GND					
24	a	Not Used					
25	b	Not Used					
	c	Not Used					
4-5 14-15	D-E P-R	Jumpers	None	12-23	None	None	None

Table 6-6: JN Printer Port Interconnect

Note(S):

- The 8806/8860 pin numbers are for the 8806 printer and the desk version of the 8860 using the adapter plug supplied with the 8860. The 8806/8860 pin letters are for the washdown version of the 8860 printer only.
- The jumper shown between pins 14 and 15 (desk and rack enclosure) or between pins P and R (wall mount enclosure) of the JN port must be installed in the 8142 end of the interface cable to enable 20 mA output. The 8843 printer uses the RS-232 interface and does not require the jumper between 14 (P) and 15 (R) on the 8142 end of the cable.
- The jumper shown between pins 12 and 23 must be installed in the 8806 end of the interface cable and remote ASCII input must be disabled **[F5.17 0]** for the remote print button on the Model 8806 printer to operate.

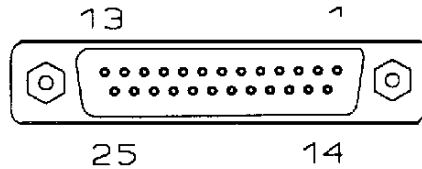

Figure 6-14: Desk & Rack Enclosure Versions. DB-25, Serial Connector

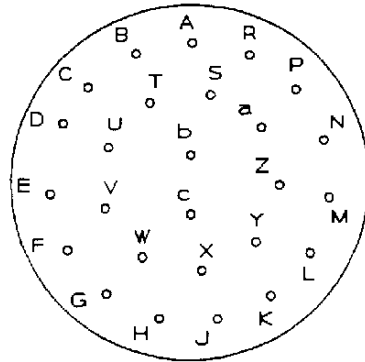

Figure 6-15: Wall Enclosure Versions. Twist Lock, Serial Connector

6.4.1.1. Handshaking Signals And Remote Print Pushbutton Interfacing

RTS -(Request To Send) This RS-232C output line is always held at +12 VDC.

CTS -(Clear To Send) This RS-232C input line controls when the JN port is able to transmit. If this line is held between -25 VDC to -3 VDC the JN port will not be able to send data. If this line is held between +3 VDC to +25 VDC or allowed to float (e.g. not be connected) the JN port is free to output data.

DSR -(Data Set Ready) This RS-232C input line acts as a remote print input. If this line is held at 0 VDC for approximately 300 ms a print request will occur. DO NOT use this input for cable distances greater than 25' or in electrically noisy environments.

DTR -(Data Terminal Ready) This RS-232C output line is held at +12 VDC to indicate the 8142 is powered on.

6.4.1.1. Remote Print Pushbutton

The JN port 20 mA RxD input can be used as a remote print pushbutton input if remote ASCII input is disabled [F5.17 0]. The remote switch can be located up to 2000 feet from the 8142. Use a shielded, twisted pair cable and ground the shield of the cable to the chassis of the 8142. Figure 6-16 details the remote print pushbutton wiring.

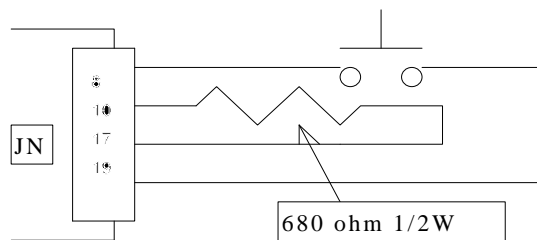

Figure 6-16: 20 mA Remote Print Pushbutton

Note: The 680Ω ½W resistor shown **MUST** be included to limit the current draw to 20 mA.

6.4.2. Demand Mode Output Format

The 8142 will transmit serial data when a print request is issued using the PRINT pushbutton, AutoPrint, or a remote print command from either a remote print pushbutton or a single ASCII command character input from a host computer. The line format, baud rate and checksum are selectable in the setup mode.

Demand output is inhibited when the scale is "in motion", when the weight is under gross zero or over capacity. If the demand output was inhibited because of motion or a over capacity or under zero condition then the print request will be stored and acted upon as soon as the 8142 is no longer inhibited to output data. The demand output is also controlled by the minimum print and print interlock selections.

6.4.2.1. Displayed Weight Only Format

Gross Weight																	
Data	S T X	S O	M S D	-	-	-	-	-	L S D	S P	L / k	B / g	S I	C R	C K S	L F	
Note	1	2	3						4	5	2	6	7	9			

Net Weight																					
Data	S T X	S O	M S D	-	-	-	-	-	-	L S D	S P	L / k	B / g	S P	N	E	T	S I	C R	C K S	L F
Note	1	2	9									4	5	4	10			2	6	7	9

6.4.2.2. Single Line: Gross, Tare, Net

Single line gross weight format is assumed if no tare weight has been taken.

Single Line: Gross, Tare, Net																							
Data	S T X	S O	M S D	-	-	-	-	-	L S D	S P	L / k	B / g	S P	M S D	-	-	-	-	-	L S D	S P	L / k	B / g
Note	1	2	3						4	5	4	3						4	5				

Single Line: Gross, Tare, Net (Continued)																								
Data	S P	T	R	S P	M S D	-	-	-	-	-	L S D	S P	L / k	B / g	S P	N	E	T	S I	C R	C K S	L F		
Note	4	10			4	9						4	5	4	10			2	6	7	9			

6.4.2.3. Multi Line: Gross, Tare, Net

Single line gross weight format is assumed if no tare weight has been taken.

Gross Weight

Data	S T X	M S D	-	-	-	-	-	L S D	S P	L / k	B / g	C R	C K S	L F
Note	1	3							4	5	6	7	9	

Tare Weight

Data	M S D	-	-	-	-	-	L S D	S P	L / k	B / g	S P	T	R	C R	C K S	L F
Note	3							4	5	4	10	6	7	9		

Net Weight

Data	S O	M S D	-	-	-	-	-	L S D	S P	L / k	B / g	S P	N	E	T	S I	C R	C K S	L F
Note	2	9							4	5	4	10			2	6	7	9	

6.4.2.4. Demand Format Notes:

Single line gross, tare, net and multi line gross, tare, net formats use single line gross weight output format when tare is not in use.

- 1 - <STX> ASCII Start of Text character, Hex 02. Transmitted at beginning of first line of data only.
- 2 - <SO>/<SI> ASCII Shift Out and Shift In characters, Hex 0E / 0F, (expanded print).
- 3 - The gross weight and tare weight data fields are right justified and padded with spaces to 7 digits.
- 4 - <SP> ASCII Space character, Hex 20.
- 5 - <Units> Display units (LB, kg, or t). As selected in setup and by the lb/kg key.
- 6 - <CR> ASCII Carriage Return character, Hex 0D.
- 7 - <CKS> Checksum character, 2's complement of the 7 low order bits of the binary sum of all characters on a line, preceding the checksum.
- 8 - <LF> ASCII Line Feed character, Hex 0A.
- 9 - The net weight field is right justified and padded with spaces to 8 digits.
- 10 - Weight field descriptors. These descriptions are printed to identify the tare and net weight fields.

6.4.3. JN Port Toledo® Continuous Format

One continuous format data output occurs every A/D update (from 4 to 8 per second). The continuous format output is useful when the scale weight and status data need to be read while the scale is "in motion". Single character remote commands for clear, tare, print and zero are accepted in the continuous output mode, if remote ASCII input is enabled [F5.17 1] or [F5.17 2]. Bit 3 in status word C is set "true" (equal to a one), for one data output when a print request occurs.

JN Port Continuous Output Format

Data	S T X	S W A	S W B	S W C	M S D	-	-	-	-	L S D	M S D	-	-	-	-	L S D	C R	C K S
Note	1	2			3					4				5	6			

CONTINUOUS DATA FORMAT NOTES:

- 1 - <STX> ASCII Start of Text character, Hex 02.
- 2 - <SWA>, <SWB>, <SWC> Status Word A, B, C. Refer to JN Status Word A, B and C definitions, following.
- 3 - Displayed weight. Six digits, no decimal point or sign. Nonsignificant leading zeros are replaced with spaces in the lb weight unit mode.
- 4 - Tare weight. Six digits, no decimal point or sign.
- 5 - <CR> ASCII Carriage Return, Hex 0D.
- 6 - <CKS> Checksum character, 2's complement of the 7 low order bits of the binary sum of all characters on a line, preceding the checksum including the STX and CR.

Function	Selection	Bit							
		6	5	4	3	2	1	0	
Decimal Point or Dummy Zero	X00	A	A			0	0	0	
	X0	L	L			0	0	1	
	X	W	W			0	1	0	
	0.X	A	A	*		0	1	1	
	0.0X	Y	Y			1	0	0	
	0.00X	S	S			1	0	1	
	0.000X					1	1	0	
	0.0000X	A	A			1	1	1	
Increment Size	X = 1	0	1	0	1	*			
	X = 2	1	0	1	0				
	X = 5	1	1	1	1				

JN Port Status Word A Bit Definitions
(* Bits Not Applicable to Function)

Function	Bit
Gross/Net, Net = 1	0
Under Zero, Negative = 1	1
Overcapacity = 1	2
Motion = 1	3
lb/kg, kg = 1	4
Always a 1	5
Powerup Not Zeroed = 1	6

JN Port Status Word B Bit Definitions

Function	Bit
Always a 0	0
Always a 0	1
Always a 0	2
Print Request = 1	3
Expanded Weight = 1	4
Always a 1	5
Manual tare in kg = 1	6

JN Port Status Word C Bit Definitions

6.4.3.1. Toledo® Continuous Short Mode

The continuous short mode format is provided to allow continuous data output while maintaining high speed update rates. The continuous short format is identical to the standard continuous format except that the tare weight field is not transmitted.

JN Continuous Short Mode Format

Data	S T X	S W A	S W B	S W C	M S D	-	-	-	-	L S D	C R	C K S
Note	1	2		3				4	5			

Continuous Short Mode Format Notes:

- 1 -<STX> ASCII Start of Text character, Hex 02.
- 2 -Status Words A, B, and C. Refer to JN for status word descriptions in Section 6.4.3.
- 3 -Displayed weight. Six digits, no decimal point or sign. Nonsignificant leading zeros are replaced with spaces in the lb weight unit mode.
- 4 -<CR> ASCII Carriage Return character, Hex 0D.
- 5 -<CHK> Optional Checksum character. Checksum is defined as the 2's complement of the 7 bit sum of all the characters preceding the checksum character including the STX and CR.

6.4.4. JN Port Remote Input Commands

The JN port accepts specific uppercase ASCII remote commands. This input must be in the same data format and baud rate as the data output selected in setup. Remote commands are subject to the same restrictions as their keyboard equivalents.

There must be a time delay of at least ½ second (500 milliseconds) between each remote ASCII command character. There must be no carriage return <CR> or linefeed <LF> characters sent after a command character. If demand/continuous output mode is selected, setup step [F5.17 2], the JN port will respond to an ASCII <Enq>, hex 05 with one continuous format data output.

Character	Keyboard Equivalent
C	CLEAR Key
P	PRINT Key
T	TARE Key
Z	ZERO Key

Note:If remote input commands are enabled, setup step [F5.17 1] or [F5.17 2] then the remote pulse input is disabled. **This will disable the PRINT key on the Model 8806 Printer.**

6.5. JW SETPOINT PORT

The Dual Display Advanced versions supply a second interface port with a RS-232C interface for input and output of serial data in a setpoint version of the Toledo® continuous format. Single ASCII Characters for Clear, Print, Tare and Zero functions are accepted, identically to the JN Port. TTL setpoint output and 20 mA, remote pushbutton inputs are also supplied. The data format used by the JW port is either a 10 or 11 bit ASCII frame which consists of: 1 start bit, 7 data bits, 1 selectable parity bit and 1 or 2 stop bits. A selectable checksum character is provided to ensure the integrity of the data. Baud rate selection is 1200, 2400, 4800 or 9600 baud. The Dual Display version can supply the 20 mA, remote pushbutton input only if the optional Gross/Tare/Print KOP is installed.

6.5.1. JW Port Connector Pinout

Signal Description	Desk/Rack Pin	Wall Pin
Chassis Ground	1	A
TxD RS-232C	2	B
RxD RS-232C	3	C
RTS RS-232C	4	D
CTS RS-232C	5	E
Keyboard Inhibit RS-232	6	F
Logic Ground	7	G
RxD (TTL)	8	H
- Remote Clear Input 20 mA	9	J
TxD (TTL)	10	K
Logic Ground	11	L
Setpoint 1	12	M
Setpoint 2	13	N
+ Remote Tare Input 20 mA	14	P
+12 VDC (20 mA Supply)	15	R
+ Remote Clear Input 20 mA	16	S
-12 VDC (20 mA Supply)	17	T
- Remote Tare Input 20 mA	18	U
+5 VDC (Setpoint Supply)	19	V
DTR RS-232C	20	W
Setpoint 3/Setpoint 1 Fast	21	X
+5 VDC (Setpoint Supply)	22	Y
Setpoint 4/Setpoint 2 Fast	23	Z
Tolerance 1	24	a
Tolerance 2	25	b
Not Used		c

Table 6-7: JW Port Connector Pinout

The JW port utilizes the same style of connectors as the JN port, except that the wall enclosure versions are keyed differently to prevent swapping of the JN port and JW port cables. Refer to Figures 6-14 and 6-15 in Section 6.4.1 for connector diagrams.

6.5.2. Handshaking Signal Descriptions

RTS - (Request To Send) This RS-232C output line is always held at +12 VDC.

CTS - (Clear To Send) This RS-232C input line controls when the JW port is able to transmit. If this line is held between -25 VDC to -3 VDC the JW port will not be able to send data. If this line is held between +3 VDC to +25 VDC or allowed to float (e.g. not be connected) the JW port is free to output data.

DTR - (Data Terminal Ready) This RS-232C output line is held at +12 VDC to indicate the 8142 is powered on.

Keyboard-Inhibit (Keyboard Inhibit) This RS-232C input line acts as keyboard inhibit. The keyboard inhibit input is supplied to lockout certain operations to prevent interference with material feeding process (setpoint). If this line is held between -25 VDC to -3 VDC the following keyboard operations are disabled.

- CLEAR key self test. The CLEAR key is still active for all other functions.
- SETPOINT SELECT key. Entry of setpoint data is inhibited.
- SETUP key. All setup functions are disabled except resetting CN.
- lb/kg units switching is disabled.

6.5.3. 20 mA Remote Pushbutton Inputs

The JW port provides the ability to connect external pushbuttons located up to 2000 feet from the 8142 for remote clear, tare and print functions. The remote pushbutton inputs are subject to the same restrictions as normal keyboard operations.

All remote pushbutton inputs use the same procedure. The remote input must be turned ON for between 300 ms to 3 seconds, then turned OFF. A current flow of between 18 to 45 mA will turn the input ON.

Remote input clear, tare, print KOPs are available to add the remote pushbutton input capability to dual display versions of the 8142. Refer to Section 8.3. for part numbers of the remote gross, tare, print input KOP's. These remote clear, tare, print KOP do not allow use of the JW Serial port or setpoint cutoff outputs with a dual display versions, only the dual display advanced versions supply these functions.

6.5.3.1. Remote Tare Input

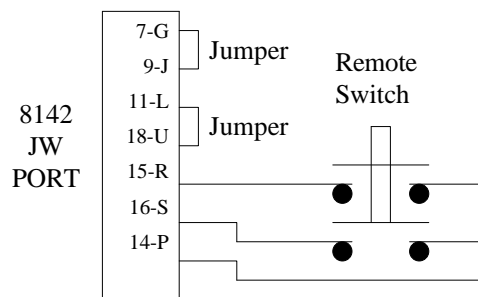

Figure 6-17: JW Port Remote Tare

6.5.3.2. Remote Clear Input

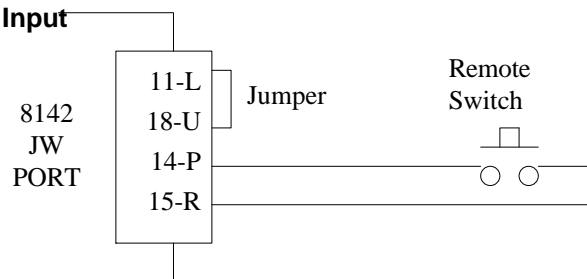

Figure 6-18: JW Port Remote Clear Input

6.5.3.3 Remote Print Input

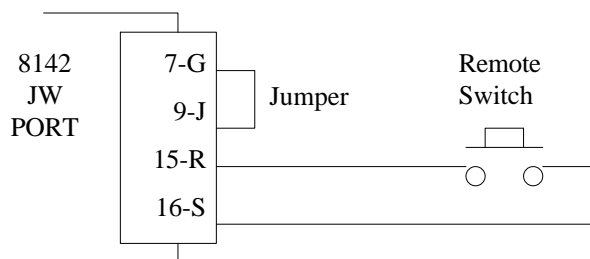



Figure 6-19: JW Port Remote Print Input

6.5.4. JW Port TTL Setpoint Operation

Refer to installation precautions for setpoint applications in Section 4.4.

 WARNING
WHEN THIS EQUIPMENT IS INCLUDED AS A COMPONENT PART OF A SYSTEM, THE RESULTING DESIGN MUST BE REVIEWED BY QUALIFIED PERSONNEL WHO ARE FAMILIAR WITH THE CONSTRUCTION AND OPERATION OF ALL COMPONENTS IN THE SYSTEM AND POTENTIAL HAZARDS INVOLVED.
IF THIS DEVICE IS USED IN AN AUTOMATIC OR MANUAL FILLING CYCLE, ALL USERS MUST PROVIDE A HARD WIRED EMERGENCY STOP CIRCUIT OUTSIDE THE DEVICE CIRCUITY.
FAILURE TO OBSERVE THIS PRECAUTION COULD RESULT IN BODILY INJURY!

The 8142 JW setpoint port supplies 4 setpoint outputs and 2 tolerance outputs. The outputs for setpoint 3 and 4 are used as the fast feed outputs for setpoints 1 and 2 when in the 2 setpoint mode. All setpoint outputs are TTL compatible (0 and 5 VDC level), low true ("ON" = 0 VDC). An "ON" TTL output (0 VDC), can sink up to 20 mA of current. An "OFF" TTL output (+5 VDC), will not source any appreciable current.

The TTL setpoint outputs operate on the absolute value of the displayed weight and are usable as feed in or feed out setpoints.

Refer to Figure 6-20 for an example of buffering the TTL output with a relay. A coil resistance of 500Ω is recommended. The combined total load of all the outputs on the +5 VDC supplied by the JW port **MUST NOT** exceed 100 mA or indicator lockups and erratic operation can result.

The setpoint outputs are "ON" any time the displayed weight is less than the programmed setpoint value. The setpoint outputs **MUST NOT** be connected directly to feeders or valves. External Start/Stop interlock circuitry **MUST** be provided for a setpoint output to be usable in a feeder control application.

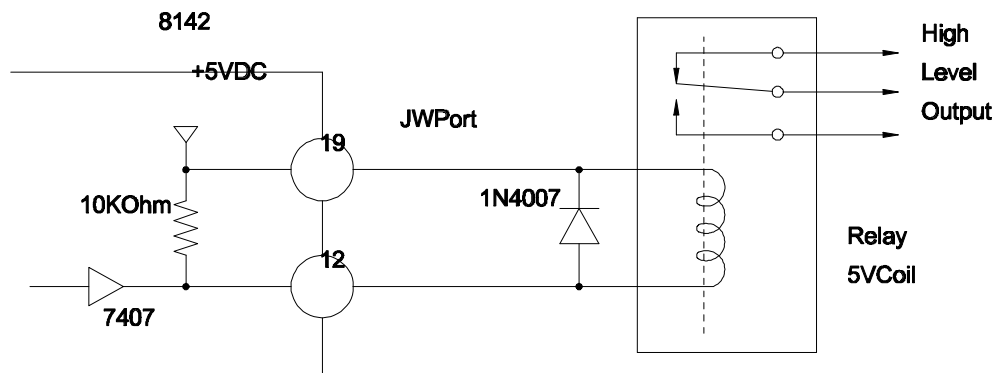

Figure 6-20: TTL Output Interfacing Example

Toledo Scale provides a separate enclosure with high level switching if requested. Additional custom designed start/stop control logic is also available on request.

6.5.5. JW Port Continuous Format Output

One continuous format data output occurs every A/D update (from 4 to 8 per second). The continuous format output is useful when the scale weight and status data need to be read while the scale is "in motion". Single character remote commands can be accepted in the continuous output mode. Bit 3 in status word C is set "true" (equal to a one), for one data output when a print request occurs.

JW Port Continuous Output Format

Data	S T X	S W A	S W B	S W C	M S D	-	-	-	-	L S D	M S D	-	-	-	-	L S D	C R	C K S
Note	1	2		3				4				5	6					

CONTINUOUS DATA FORMAT NOTES:

- 1 - <STX> ASCII Start of Text character, Hex 02.
- 2 - <SWA>, <SWB>, <SWC> Status Word A, B, C. Refer to JW Port Status Word A, B and C definitions following.
- 3 - Displayed weight. Six digits, no decimal point or sign. Non-significant leading zeros are replaced with spaces in the lb weight unit mode.
- 4 - Tare weight. Six digits, no decimal point or sign.
- 5 - <CR> ASCII Carriage Return, Hex value 0D
- 6 - <CKS> Optional Checksum Character, 2's complement of the 7 low order bits of the binary sum of all characters on a line, preceding the checksum.

Function	Decimal Point Selection	Bit		
		2	1	0
Decimal Point or Dummy Zero	X00	0	0	0
	X0	0	0	1
	X	0	1	0
	0.X	0	1	1
	0.0X	1	0	0
	0.00X	1	0	1
	0.000X	1	1	0
0.0000X	1	1	1	
Function		Bit		
Setpoint 1, Feeding = 0		3		
Setpoint 2, Feeding = 0		4		
Always a 1		5		
Setpoint 3/Setpoint 1 Fast, Feeding = 0		6		

JW Port Status Word A Bit Definitions

Function	Bit
Gross/Net, Net = 1	0
Under Zero, Negative = 1	1
Overcapacity = 1	2
Motion = 1	3
lb/kg, kg = 1	4
Always a 1	5
Tolerance 1, In Tolerance = 0	6

JN Port Status Word B Bit Definitions

Function	Bit
Always a 0	0
Always a 0	1
Always a 0	2
Print Request = 1	3
Setpoint 4/Setpoint 2 Fast, Feeding = 0	4
Always a 1	5
Tolerance 2, In Tolerance = 0	6

JN Port Status Word C Bit Definitions

6.5.6. JW Port ASCII Remote Commands

The JW port accepts specific uppercase ASCII remote commands if remote command input is enabled [F8.3 2] or [F8.3 3]. This input must be in the same data format and baud rate as the data output selected in setup. Remote commands are subject to the same restrictions as their keyboard equivalents.

There must be a time delay of at least ½ second (500 milliseconds) between each remote ASCII command character. There must be no carriage return <CR> or linefeed <LF> characters sent after a command character.

Character	Keyboard Equivalent
C	CLEAR Key
P	PRINT Key
T	TARE Key
Z	ZERO Key

6.6. JY Host Port

On dual display advanced versions only, an optional JY Host port may be installed for advanced computer interfacing applications.

The JY port supplies either RS-232C for single scale to computer interfacing or a multidrop RS-485 interface that allows up to 8, 8142 indicators to be connected to a single, 2 wire, RS-485, half duplex port of a host computer. Both the RS-232C and the RS-485 interface use the same communication protocol.

The data format used by the JY Port is either a 10 or 11 bit ASCII frame which consists of: 1 start bit, 7 data bits, 1 selectable parity bit and 1 or 2 stop bits. A selectable checksum character is provided to ensure the integrity of the data. Baud rate selection is 1200, 2400, 4800 or 9600 baud.

6.6.1. JY Host Port Interconnect

The JY port utilizes the same style of connectors as the JN port, except that the wall enclosure versions are keyed differently to prevent swapping of the JN port and JY port cables. Refer to Figures 6-14 and 6-15 in Section 6.4.1 for JW Port connector diagrams.

Signal Description	Desk Rack	Wall
Chassis Ground	1	A
TxD RS-232C	2	B
RxD RS-232C	3	C
RTS RS-232C	4	D
CTS RS-232C	5	E
DRS RS-232C	6	F
Logic Ground	7	G
Not Used	8	H
Not Used	9	J
Not Used	10	K
Not Used	11	L
Com B RS-485	12	M
Com A RS-485	13	N
Not Used	14	P
+12 VDC	15	R
Not Used	16	S
-12 VDC	17	T
Not used	18	U
Not Used	19	V
DTR RS-232C	20	W
Logic Ground	21	X
Logic Ground	22	Y
Not Used	23	Z
Not Used	24	a
Not Used	25	b
Not Used		c

Table 6-8 :JY Port Connector Pinout

6.6.2. Handshaking Signal Descriptions

- RTS - (Request To Send) This RS-232C output line is normally at -12 VDC. When the JY port is ready to transmit data, the RTS line will pulse to +12 VDC for approximately 500 ms.
- CTS - (Clear To Send) This RS-232C input line controls when the JY port is able to transmit. If this line is held between -25 VDC to -3 VDC data output is inhibited.
- DSR - (Data Set Ready) Not Used.
- DTR - (Data Terminal Ready) This RS-232C output line is held at +12 VDC to indicate the 8142 is powered on.

6.6.3. JY Port Interface Protocol

The JY port never transmits without a command to do so from the host computer. This master/satellite protocol allows multiple 8142's to be connected in parallel to a single host device by means of the multidrop RS-485 interface. Each 8142 is assigned a unique scale address in setup, from 2 to 9, to distinguish one 8142 from another.



CAUTION

The JY port receive data input is a direct interrupt to the 8142. Continuously polling the JY Port for weight data will interfere with A/D conversion and adversely affect the display update rate and weight settling time. DO NOT exceed 2 communication requests per second with the JY port.

IF THE 8142 IS USED IN A FILLING (SETPOINT APPLICATION), DO NOT COMMUNICATE WITH THE JY PORT DURING THE FILLING CYCLE. THE DISPLAY UPDATE RATE WILL BE AFFECTED AND CAN RESULT IN INCORRECT CUTOFF OPERATION AND OVERWEIGHT DELIVERY.

There are 2 basic types of communication that occur between the host and the 8142.

- Upload - The host requests information from the 8142, and the 8142 responds to the request.
- Download- The host transmits new data to the 8142.

6.6.3.1. JY Port Data Packet Format

All transmissions by the host or the 8142 JY port must be in the data packet format shown:

JY Port Data Packet Format

Data	S T X	A D R	D I R	F C T	Data Field	C R	C H K
Notes	1	2	3	4	5	6	7

JY Port format Notes:

- 1 - <STX> ASCII Start of Text Character, Hex 02.
- 2 - <ADR> 8142 scale address selected in setup, must be from an ASCII 2 to 9.
- 3 - <DIR> Data Direction, "U" = Upload (8142 to Host), "D" = Download (Host to 8142)
- 4 - <FCT> Function code, refer to Function Code Table 6-9.
- 5 - <Data Field> The data field is either the uploaded data from the 8142 or the downloaded data from the host. Not all function codes use the data field.
- 6 - <CR> ASCII Carriage Return, Hex 0D
- 7 - <CKS> Optional Checksum Character, 2's complement of the 7 low order bits of the binary sum of all characters on a line, preceding the checksum.

6.6.4. JY Host Port Function Codes

The function code in the data packet determines what operation or data is assessed in the 8142. The codes for the various functions are listed in the Function Code Table with the valid direction of the communication (upload or download) and the length of the transmitted data field.

No error detection beyond checksum is provided for downloads by the JY port. When critical data such as setpoint data is downloaded from the host to the 8142, it is recommended that the host device upload (read back) the data downloaded to the 8142 to verify that the data was received correctly.

Function Code Description	Function Code		Direction	Data Field Length
	Hex	ASCII		
All Functions	41	A	U	187
Displayed Weight	42	B	U	7
Gross Weight	43	C	U	7
Tare Weight	44	D	U/D	7
Net Weight	45	E	U	7
Time and Date	46	F	U/D	12
Next Consecutive Number	47	G	U/D	6
Clear JN Port Print Buffer	48	H	D	0
Status Bytes	49	I	U	6
Setup Bytes	4A	J	U/D	9
Control Bytes	4B	K	D	3
Setpoints 1,2,3,4	4C	L	U/D	24
Zero Tolerance 1,2	4D	M	U/D	12
#1 Setpoint, Dribble, Preact, Tolerance	4E	N	U/D	24
#2 Setpoint, Dribble, Preact, Tolerance	4F	O	U/D	24
ID	50	P	U/D	6
Read JN Port Print Buffer	51	Q	U	45

Table 6-9: JY Host Port Function Code

Note: Decimal points, weight units and descriptors are not included in data fields.

6.6.4.1. All Functions (Upload Only)

Host Transmission					
ASCII	STX	2	U	A	CR
Hex	02	32	55	41	0D

8142 Response					
STX	2	U	A	All Functions 187 Byte Data Field	CR
02	32	55	41		0D

The All Functions Data Field Consists of:

Displayed Weight: (7 Bytes)
 Gross Weight: (7 Bytes)
 Tare Weight: (7 Bytes)
 Net Weight: (7 Bytes)
 Time/Date: (12 Bytes)
 Next Consecutive Number: (6 Bytes)
 Status Bytes: (6 Bytes)

Setup Bytes: (12 Bytes)
 Setpoints 1,2,3,4: (24 Bytes)
 Setpoint-1, Dribble-1, Preact-1, Tol-1: (24 Bytes)
 Setpoint-2, Dribble-2, Preact-2, Tol-2: (24 Bytes)
 ID: (6 Bytes)
 Print Buffer: (45 Bytes)

Notes:

1 -The most significant digit of the weight data fields will be a space for positive weights and a minus for negative weights.

2 -Weight data fields never contain decimal point or dummy zero.

6.6.4.2. Displayed Weight (Upload Only)

Host Transmission					
ASCII	STX	2	U	B	CR
Hex	02	32	55	42	0D

8142 Response					
STX	2	U	B	Displayed Weight 7 Byte Data Field	CR
02	32	55	42		0D

6.6.4.3. Gross Weight (Upload Only)

Host Transmission					
ASCII	STX	2	U	C	CR
Hex	02	32	55	43	0D

8142 Response					
STX	2	U	C	Gross Weight 7 Byte Data Field	CR
02	32	55	43		0D

6.6.4.4. Tare Weight (Upload/Download)

Upload:

Host Transmission					
ASCII	STX	2	U	D	CR
Hex	02	32	55	44	0D

8142 Response					
STX	2	U	D	Tare Weight 7 Byte Data Field	CR
02	32	55	44		0D

Download:

Host Transmission						
ASCII	STX	2	D	D	Tare Weight 7 Byte Data Field	CR
Hex	02	32	44	44		0D

6.6.4.5. Net Weight (Upload Only)

Host Transmission					
ASCII	STX	2	U	E	CR
Hex	02	32	55	45	0D

8142 Response					
STX	2	U	E	Net Weight	CR
				7 Byte Data Field	
02	32	55	45		0D

6.6.4.6. Time/Date (Upload/download)

The date format downloaded to the 8142 must match the date format selected in setup, **[F5.13]**.

Upload:

Host Transmission					
ASCII	STX	2	U	F	CR
Hex	02	32	55	46	0D

8142 Response					
STX	2	U	F	Time and Date	CR
				12 Byte Data Field	
02	32	55	46		0D

Download:

Host Transmission						
ASCII	STX	2	D	F	Time and Date	CR
					12 Byte Data Field	
Hex	02	32	44	46		0D

6.6.4.7. Next Consecutive Number (Upload/Download)

Upload:

Host Transmission					
ASCII	STX	2	U	G	CR
Hex	02	32	55	47	0D

8142 Response					
STX	2	U	G	Next Consecutive Number	CR
				6 Byte Data Field	
02	32	55	47		0D

Download:

Host Transmission						
ASCII	STX	2	D	G	Next Consecutive Number	CR
					6 Byte Data Field	
Hex	02	32	44	47		0D

6.6.4.8. Clear Print Buffer (Download only)

Host Transmission					
ASCII	STX	2	D	H	CR
Hex	02	32	44	48	0D

6.6.4.9. Status Bytes (Upload Only)

Host Transmission					
ASCII	STX	2	U	I	CR
Hex	02	32	55	48	0D

8142 Response					
STX	2	U	I	Status Bytes	CR
				6 Byte Data Field	
02	32	55	48		0D

Status Byte A Bit Definitions

Function	Selection	Bit						
		6	5	4	3	2	1	0
Decimal Point or Dummy Zero	0.0000X	A	A			0	0	0
	0.000X	L	L			0	0	1
	0.00X	W	W			0	1	0
	0.0X	A	A	*		0	1	1
	0.X	Y	Y			1	0	0
	X	S	S			1	0	1
	X0					1	1	0
	X00	A	A			1	1	1
		0	1					
Increment Size	X = 1			0	1	*		
	X = 2			1	0			
	X = 5			1	1			

(*) Bits Not Applicable to Function

Status Byte B Bit Definitions

Function	Bit
Gross/Net, Net = 1	0
Under Zero, Negative = 1	1
Overcapacity = 1	2
Motion = 1	3
lb/kg, kg = 1	4
Always a 1	5
Powerup Not Zeroed = 1	6

Status Byte C Bit Definitions

Function	Bit
Always a 0	0
Always a 0	1
Always a 0	2
Print Request = 1	3
Expanded Weight = 1	4
Always a 1	5
Always a 1	6

Status Byte D Bit Definitions

Full Scale Increments	Bits						
	6	5	4	3	2	1	0
600		R	0	0	0	0	0
1,000		E	0	0	0	0	1
1,200		S	0	0	0	1	0
1,500		E	0	0	0	1	1
2,000		R	0	0	1	0	0
2,500		V	0	0	1	0	1
3,000		E	0	0	1	1	0
4,000	A	D	0	0	1	1	1
5,000	L		0	1	0	0	0
6,000	W	F	0	1	0	0	1
8,000	A	O	0	1	0	1	0
10,000	Y	R	0	1	0	1	1
12,000	S		0	1	1	0	0
15,000		F	0	1	1	0	1
16,000	A	U	0	1	1	1	0
20,000		T	0	1	1	1	1
25,000	1	U	1	0	0	0	0
30,000		R	1	0	0	0	1
32,000		E	1	0	0	1	0
35,000			1	0	0	1	1
40,000		U	1	0	1	0	0
45,000		S	1	0	1	0	1
48,000		E	1	0	1	1	0
50,000			1	0	1	1	1

Status Byte E Bit Definitions

Function	Bit
Tolerance Mode: Zero = 0/Weight = 1	0
Setpoint Mode: 4 Setpt = 0/2 Setpt = 1	1
Reserved, Always a 0	2
Reserved, Always a 0	3
Reserved, Always a 0	4
Reserved, Always a 0	5
Always a 1	6

Status Byte F Bit Definitions

Function	Bit
Setpoint 1 Feeding	0
Setpoint 2 Feeding	1
Setpoint 3/Setpoint 1 Fast Feeding	2
Setpoint 4/Setpoint 2 Fast Feeding	3
Tolerance 1, In Tolerance = 1	4
Tolerance 2, In Tolerance = 2	5
Always a 1	6

6.6.4.10. Setup Bytes (Upload/Download)

Downloaded setup bytes are stored in RAM memory and are not saved during a power loss. Original setup is used after power loss.

Upload:

Host Transmission					
ASCII	STX	2	U	J	CR
Hex	02	32	55	4A	0D

8142 Response					
STX	2	U	J	Setup Bytes 12 Byte Data Field	CR
02	32	55	4A		0D

Download:

Host Transmission						
ASCII	STX	2	D	J	Setup Bytes 12 Byte Data Field	CR
Hex	02	32	44	4A		0D

Setup Byte A:

Function	Bit
Not Used	0
lb/kg Switching Enable = 1	1
Keyboard Tare Enable = 1	2
Not Used	3
Autoclear Tare Enable = 1	4
Analog Verify Enable = 1	5
Always a 1	6

Setup Bytes B and C:

2 ASCII characters, the hex value of the characters (from hex 00 to hex 04) is equal to the digital filter value, setup step [F4.4]. Any downloaded value greater than 04 hex will be treated as 04.

Setup Bytes D & E:

2 ASCII numeric digits equal to the motion detect sensitivity value, setup step [F4.2].

Setup Bytes F & G:

2 ASCII numeric digits equal to the motion detect window value, setup step [F4.3].

Setup Byte H:

Function	Selection	Bit		
		2	1	0
Decimal Point or Dummy Zero	0.0000X	0	0	0
	0.000X	0	0	1
	0.00X	0	1	0
	0.0X	0	1	1
	0.X	1	0	0
	X	1	0	1
	X0	1	1	0
X00	1	1	1	
Function		Bit		
Not used		3		
AZM Enable		4		
Reserved for future use		5		
Always a 1		6		

Setup Byte I:

Function		Bit		
		2	1	0
JN Port Baud Rate	1200	0	0	0
	2400	0	0	1
	4800	0	1	0
	9600	0	1	1
	300	1	0	0
Function		Bit		
Always a 1		3		
Always a 1		4		
Checksum Enabled = 1		5		
Always a 1		6		

Setup Byte J:

Function		Bit	
Output Mode: Demand = 1 Toledo® Continuous = 0		0	
Function	Selection	Bit	
		2	1
Weight Output Line Format	Displayed	0	0
	GTN Single	0	1
	GTN Multi	1	0
Function		Bit	
Always a 0		3	
Always a 0		4	
Always a 0		5	
Always a 1		6	

Setup Byte K:

Function	Selection	Bit	
		1	0
Minimum Print Increments	00	0	0
	10	0	1
	20	1	0
	30	1	1
Function		Bit	
Reserved for Future Use		2	
Reserved for Future Use		3	
Reserved for Future Use		4	
Reserved for Future Use		5	
Always a 1		6	

Setup Byte L:

Reserved for future use. Bit 6 is always a 1, all other bits are ignored.

6.6.4.11. Control Bytes

Only 1 control byte function can be used at a time. If more than 1 control byte function is desired then repeat the control byte function once for each function desired.

Control bytes B and C are used to control what will be displayed on the auxiliary display.

Download:

Host Transmission								
ASCII	STX	2	D	K	C B A	C B B	C B C	CR
Hex	02	32	44	4B				0D

Control Byte A (CBA): Bit Definition

Function	Bit
PRINT REQUEST = 1	0
SWITCH TO LB = 1	1
SWITCH TO kg = 1	2
CLEAR TARE = 1	3
AUTOTARE = 1	4
ZERO = 1	5
ALWAYS A 1	6

Control Byte B (CBB): Bit Definition

Function	Bit
DISPLAY TARE = 1	0
DISPLAY ID = 1	1
DISPLAY TIME = 1	2
DISPLAY DATE = 1	3
DISPLAY CN = 1	4
BLANK DISPLAY = 1	5
ALWAYS A 1	6

Control Byte C (CBC): Bit Definition

Function	Bit
DISPLAY SETPOINT 1 = 1	0
DISPLAY SETPOINT 2 = 1	1
DISPLAY SETPOINT 3 = 1	2
DISPLAY SETPOINT 4 = 1	3
RESERVED FOR FUTURE USE	4
RESERVED FOR FUTURE USE	5
ALWAYS A 1	6

6.6.4.12. Setpoints 1,2,3,4 (Upload/Download)

4 Setpoint mode only, setup step [F7.2 4]. All four setpoints must be downloaded even if only one setpoint is being changed. Each setpoint value is six numeric digits with no decimal point.

Upload:

Host Transmission					
ASCII	STX	2	U	L	CR
Hex	02	32	55	4C	0D

8142 Response					
STX	2	U	L	Setpoints 1,2,3,4 Byte Field	CR
02	32	55	4C		0D

Download:

Host Transmission						
ASCII	STX	2	D	L	Setpoints 1,2,3,4 Byte Field	CR
Hex	02	32	44	4C		0D

6.6.4.13. Zero Tolerance (Upload/Download)

4 Setpoint mode only, setup step [F7.2 4]. The value for both zero tolerances must be downloaded even if only one tolerance is being changed. Each tolerance value is six numeric digits with no decimal point.

Upload:

Host Transmission					
ASCII	STX	2	U	M	CR
Hex	02	32	55	4D	0D

8142 Response					
STX	2	U	M	Zero Tolerance 1,2	CR
				12 Byte Field	
02	32	55	4D		0D

Download:

Host Transmission						
ASCII	STX	2	D	M	Zero Tolerance 1,2	CR
					12 Byte Field	
Hex	02	32	44	4D		0D

6.6.4.14. #1 Setpoint, Dribble, Preact, Tolerance (Upload/Download)

2 Setpoint mode only, setup step [7.2 2]. Setpoint, dribble, preact and tolerance values must be downloaded even if only one value is changed. Each value is six digits without decimal point.

Upload:

Host Transmission					
ASCII	STX	2	U	N	CR
Hex	02	32	55	4E	0D

8142 Response					
STX	2	U	N	#1: Setpoint, Dribble, Preact, Tolerance.	CR
				24 Byte Field	
02	32	55	4E		0D

Download:

Host Transmission						
ASCII	STX	2	D	N	#1: Setpoint, Dribble, Preact, Tolerance.	CR
					24 Byte Field	
Hex	02	32	44	4E		0D

6.6.4.15. #2 Setpoint, Dribble, Preact, Tolerance (Upload/Download)

2 Setpoint mode only, setup step [7.2 2]. Setpoint, dribble, preact and tolerance values must be downloaded even if only one value is changed. Each value is six digits without decimal point.

Upload:

Host Transmission					
ASCII	STX	2	U	O	CR
Hex	02	32	55	4F	0D

8142 Response					
STX	2	U	O	#2: Setpoint, Dribble, Preact, Tolerance. 24 Byte Field	CR
02	32	55	4F		0D

Download:

Host Transmission						
ASCII	STX	2	D	O	#2: Setpoint, Dribble, Preact, Tolerance. 24 Byte Field	CR
Hex	02	32	44	4F		0D

6.6.4.16. Numeric ID (Upload/Download)

Upload:

Host Transmission					
ASCII	STX	2	U	P	CR
Hex	02	32	55	50	0D

8142 Response					
STX	2	U	P	ID 6 Byte Field	CR
02	32	55	50		0D

Download:

Host Transmission						
ASCII	STX	2	D	P	ID 6 Byte Field	CR
Hex	02	32	44	50		0D

6.6.4.17. Read JN Port Print Buffer (Upload Only)

This function returns last printed data.

Upload:

Host Transmission					
ASCII	STX	2	U	Q	CR
Hex	02	32	55	51	0D

8142 Response					
STX	2	U	Q	Read Print Buffer 45 Byte Field	CR
02	32	55	51		0D

Print Buffer 45 Byte Data Field Consists of:

Data	Length
Gross Weight	7
Tare Weight	7
Net Weight	7
Time	6
Date	6
CN	6
ID	6

6.7. Optional BCD/Analog K.O.P.

The BCD/Analog K.O.P. option supplies analog 4-20 mA current loop output, analog 0-10 VDC output and parallel binary coded decimal (BCD) output representing either gross or displayed weight. The BCD outputs are TTL compatible (0 VDC-5 VDC), with high true logic (greater than 2.4 VDC = ON).

TTL status outputs for motion, overcapacity and under zero and TTL control inputs for demand, hold, motion detect inhibit, and gate inputs for each weight digit are also supplied.

6.7.1. J2 BCD/Analog Interconnect

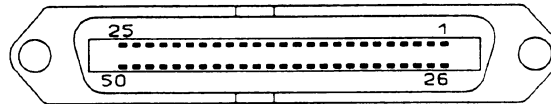

Figure 6-21: Rack Version J2 BCD/Analog Connector

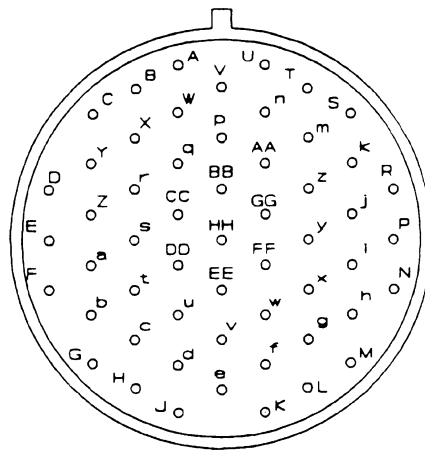

Figure 6-22: Wall Version J2 BCD/Analog Connector

Function		Direction	Rack	Wall
10,000	Ten Thousands BCD Digit	Out	1	A
40,000		Out	2	B
80,000		Out	3	C
X0,000 Gate		In	4	D
20,000		Out	5	E
1,000	Thousands BCD Digit	Out	6	F
4,000		Out	7	G
8,000		Out	8	H
X,000 Gate		In	9	J
2,000		Out	10	K
100	Hundreds BCD Digit	Out	11	L
400		Out	12	M
800		Out	13	N
X00 Gate		In	14	P
200		Out	15	R
X0 Gate	Tens BCD Digit	In	16	S
10		Out	17	T
40		Out	18	U
80		Out	19	V
20		Out	20	W
X Gate	Units BCD Digit	In	21	X
1		Out	22	Y
4		Out	23	Z
8		Out	24	a
2		Out	25	b
+5 VDC Supply (100 mA max current draw)			26	c
Chassis Ground (Shield)			30	g
Motion		Out	33	j
Net		Out	34	k
Demand		In	39	r
Sync Pulse		Out	40	s
Logic Ground			41	t
Logic Ground			42	u
Overcapacity		Out	43	v
Minus		Out	44	w
4-20 mA Current Loop Analog Output		Out	45	x
Analog Ground			46	y
0-10 VDC Analog Output		Out	47	z
Hold		In	49	BB
Motion Detect Inhibit		In	50	CC

Table 6-10: Analog/BCD Output Connector

Decimal Value		0	1	2	3	4	5	6	7	8	9
BCD Equivalent	1	0	1	0	1	0	1	0	1	0	1
	2	0	0	1	1	0	0	1	1	0	0
	4	0	0	0	0	1	1	1	1	0	0
	8	0	0	0	0	0	0	0	0	1	1

Table 6-11: BCD Outputs, Binary Representation of One Decimal Digit

6.7.2. TTL Status Outputs

All control inputs are TTL compatible. The high state is greater than 2.4 VDC and the low state is less than 0.8 VDC.

Sync:

The sync output is a negative going pulse (high to low and back to high) with a duration of ≈ 10 ms that occurs every A/D conversion (4 to 10 per second). BCD data is invalid when the sync output is low. Motion will disable the sync output unless motion detection is inhibited.

Motion:

The motion output is high when the scale is "in motion" and low when in a "no motion condition".

Minus:

The minus output is high for negative weights and low for positive weights.

Overcapacity:

The overcapacity output is high for overcapacity weights and low when the 8142 is "in range".

Net:

The net output is low when the 8142 is in the gross mode and high when a tare weight is taken.

6.7.3. TTL Control Inputs

All control inputs are TTL compatible. The high state is greater than 2.4 VDC and the low state is less than 0.8 VDC.

Gate: (Multiplexed Data)

Each BCD digit has an individual gate input. When this input is held low, the four output pins for each BCD digit float high in a high impedance (tri-state) mode. Using the gate inputs to sequentially select one BCD digit at a time, all of the BCD Data can be read into four TTL inputs. The gate inputs also permit several different 8142's BCD outputs to be multiplexed into the same set of inputs by enabling one of the 8142's gate inputs at a time.

Hold:

The hold input locks the display and BCD/Analog outputs and inhibits serial data output when held low. If this input is held high (or allowed to float) the 8142 will update the display and outputs normally.

Demand:

The demand input has the same effect as the hold input when held low. A/D conversion is also stopped. A positive going pulse (low to high and back to low) with a duration of ≈ 50 ms will force 1 A/D conversion. The display and BCD/Analog outputs will update to the new weight reading and then lock. The demand input can be repeatedly pulsed as desired to synchronize A/D conversion to external events.

Motion Detect Inhibit:

When this input is held low the sync pulse output even if the 8142 is "in motion" Jumper W1 on the BCD/Analog PCB will also inhibit motion detect.

6.7.4. Analog Output

The BCD/Analog option supplies a 12 bit analog output in 0-10 VDC and 4-20 mA current loop. If greater resolution than 1 part in 4095 (12 bit) is required then the BCD or serial data interfaces must be used instead of the analog outputs.

7. MAINTENANCE

The 8142 is designed to require a minimum of maintenance and service. This section provides instructions and procedures for maintenance of the 8142, as well as a troubleshooting guide to aid in problem analysis.

The following items and common hand tools are recommended for proper maintenance and repairs.

Volt-Ohm meter	Analog load cell simulator (100865 00A)
Cleaning cloth	Anti-static mat and wrist strap

Clean the keyboard and covers with a soft cloth that has been dampened with a mild window type cleaner. **DO NOT USE ANY TYPE OF INDUSTRIAL SOLVENT. DO NOT SPRAY CLEANER DIRECTLY ONTO THE UNIT.**

7.1. Troubleshooting

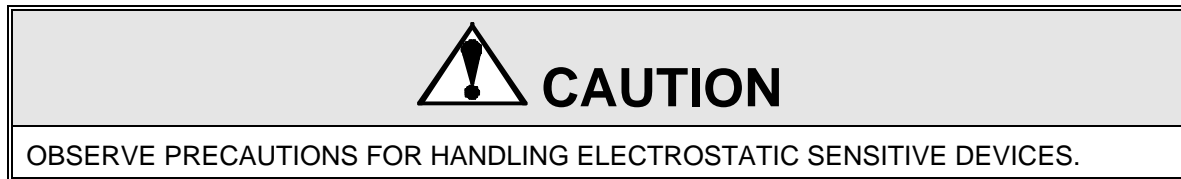

Perform the troubleshooting procedures listed in order until the malfunction is corrected.

- 1 - Record as much information as possible about the problem. If an error code is displayed, refer to the error code table in Section 7.3. for specific suggestions.
- 2 - Cycle the AC power to the 8142 off then back on.
- 3 - Check the power fuse and AC power. Verify that external wiring (load cell cable, printer cable) is connected properly and has not been damaged.
- 4 - Verify that the 8142 has been properly programmed in setup.
- 5 - Verify that all power supply voltages listed in section 7.2. are present and correct.
- 6 - Use substitution of known good parts to correct the malfunction.
- 7 - Once the 8142 is operational, verify the problem by reinstalling the defective component and retesting the 8142. This is to prevent replacing a good component because of a bad connection.
- 8 - Consult the setup section of this manual for proper programming. Do not copy the setup of the suspected faulty PCB without verification as the problem may be caused by a programming error.
- 9 - Exchange PCBs and subassemblies are available from your authorized Toledo Scale representative.

7.2. Error Codes

The 8142 has 2 types of error codes, operational errors and calibration errors.

7.2.1. Operational Error Codes

-Operational error codes can occur during powerup or while the 8142 is in normal operation. Do not use the operational error codes table for error that may occur during calibration.

-If an operational error code occurs cycle the AC power off, wait 15 seconds then turn back on. If error code persists then refer to Table 7-1.

-[E1], [E2], [E3] and [E13] (Program ROM, RAM, NOVRAM and Dual Display NOVRAM errors) indicate a checksum error for the a specified memory chip. Chip memories are tested at powerup.

-[E6] and [E8] indicates an analog verify failure. Analog verify tests occur every 4 hours. (F4.6 1) enables analog verify.

-[AAAAAA] indicates an analog verification cycle is in progress.

-[SP Err] indicates that the setpoint data is corrupt and must be reentered.

-[E E E] or [-E E E] indicates the 8142 has not captured zero and tare interlock is enabled.

-[J2 OFF] Enter setup, then exit setup and answer "1" to SFILE. If problem persist after completing the preceding check power and setpoint relays for power problems.

Error	Error Description	Recommended Corrective Action
E1	Program ROM Fault	1. Try power down/wait/power up. 2. Replace Main PCB
E2	RAM Fault	1. Try power down/wait/power up. 2. Replace Main PCB
E3	Setup NOVRAM Fault	1. Try power down/wait/power up. 2. Reprogram setup. 3. Replace Main PCB
E4	Printer Error	Check printer and interconnect harnesses
E5	Display Verify Failure	Replace Display PCB.(Set F4.6 to 0)
E6	Analog Verify Failure	Scale has not returned to zero. Recalibrate. (Set F4.6 to 0)
E7	Analog Fault	1. Check load cell and cables. 2. May be faulty wiring.
E13	NOVRAM Fault EEPROM Error	Recalibrate. Xicor on Dual Disp. Bad. Failed Checksum
PR Fail	Displayed at power loss.	Not an error condition
AAAAAA	Analog Verify in Progress	Not an error condition.
SP Err	Setpoint Error	1. Press the SELECT SETPOINT key and reenter setpoint values. 2. If error reoccurs then verify setpoint precautions described in Section 4.4.
E E E -E E E	Out of Zero Capture Range Over or Under	1. Press the ZERO key. 2. Check load cell and cables. 3. Recalibrate. 4. Replace Main PCB.

Table 7-1: Operational Error Codes

7.2.2. Calibration Error Codes

The calibration error code table applies only to error codes displayed during the calibration procedure in setup.

A [CAL E6] calibration error may also be caused by a miswired load cell or a mechanical bind in the scale base.

Error	Error Description	Recommended Corrective Action
CAL E1	Scale in Motion	1. Check Load Cell, Cable 2. Replace Main PCB
CAL E2	A/D Malfunction Span cal. exceeds range limits	1. Recalibrate 2. Replace Main PCB
CAL E3	Calibration Error Insufficient test weight used.	1. Reprogram setup. 2. Replace Main PCB
CAL E4	Scale out of Range (Over or Under)	1. Check Load Cell, Cable 2. Replace Display PCB. 3. Check W7 jumper
CAL E5	Capacity Error	1. Recalibrate. 2. Microvolt build too small or too big
CAL E6	Insufficient Test Weight, not enough signal change from Load Cell	1. Verify amount of test weights. 2. Check load cell and cables. 3. Replace Main PCB.
CAL E8	Illegal Test Weight Entered	Recalibrate with test weights less than 125% of full scale.

Table 7-2: Calibration Error Codes

7.3. Power Supply Voltage Checks

All voltage measurements listed assume that the AC power is within the specified range of 100 to 130 VAC. All measurements were made using a 3½ digit Digital Multimeter.

 WARNING
ONLY PERMIT QUALIFIED PERSONNEL TO SERVICE THIS EQUIPMENT. EXERCISE CARE WHEN MAKING CHECKS THAT MUST BE MADE WITH POWER ON.

 CAUTION
OBSERVE PRECAUTIONS FOR HANDLING ELECTROSTATIC SENSITIVE DEVICES.

7.3.1. Main PCB Voltage Checks

*All DC voltages listed are referenced to chassis ground (minus meter lead to chassis ground). Refer to Figure 6-1 in Section 6.1.1. for connector locations, Figures 7-1 and 7-2 for component locations.

*If any of the listed DC voltages are not present or are out of specification then check the AC transformer voltage listed in Section 7.3.3.

Voltage	Description	Acceptable Voltage		Maximum AC Ripple	Plus Meter Lead	Notes
		Minimum	Maximum			
+12.5 VDC	Load Cell Excitation	+12.4	+12.6	0.01	J1-9	1
+10 VDC	Raw +5 Supply	+8	+12	0.3	J3-2	2
+5 VDC	+5 Main PCB	+4.75	+5.25	0.02	+C31	3
+5 VDC	+5 Display PCB	+4.75	+5.25	0.02	+C2	4
+15 VDC	Analog Supply	+14.75	+15.25	0.02	+C48	5
+22 VDC	+ Raw Supply	+17	+25	0.5	JN-15	6
-22 VDC	- Raw Supply	-17	-25	0.5	JN-17	7
+12 VDC	+ RS-232 Supply	+11.5	+12.5	0.02	+CR10	8
-12 VDC	- RS-232 Supply	-11.5	-12.5	0.02	-CR9	9
+39 VDC	Display Supply	+32.5	+40.5	0.75	A5-10	10

Table 7-3: Main PCB Voltage Checks

*Main PCB Voltage Checks Notes:

- 1 - **+12.5 VDC:** Load cell excitation voltage, (connector J1 pin 9). Intrinsically safe versions supply +5 VDC load cell excitation.
- 2 - **+10 VDC:** Raw +5 VDC logic supply, (connector J3 pin 2)
- 3 - **+5 VDC:** Regulated control logic supply, (plus side of capacitor C31, Figure 7-1).
- 4 - **+5 VDC:** Regulated display logic supply, (plus side of capacitor C2, Figure 7-2).
- 5 - **+15 VDC:** Analog circuitry supply, (plus side of capacitor C48, Figure 7-1).
- 6 - **+22 VDC:** JN port 20 mA current loop + supply, raw +12 VDC supply, raw +15 VDC supply and raw +39 VDC supply, (connector JN, pin 15)
- 7 - **-22 VDC:** JN port 20 mA current loop - supply, raw supply for -12 VDC, (connector JN, pin 17).
- 8 - **+12 VDC:** JN Port RS-232 Supply, (plus side of diode CR10, Figure 7-1).
- 9 - **-12 VDC:** JN Port RS-232 Supply, (minus side of diode CR9, Figure 7-1).
- 10 - **+39 VDC:** Display Voltage, single display versions only, (A5 pin 10, Figure 7-1).

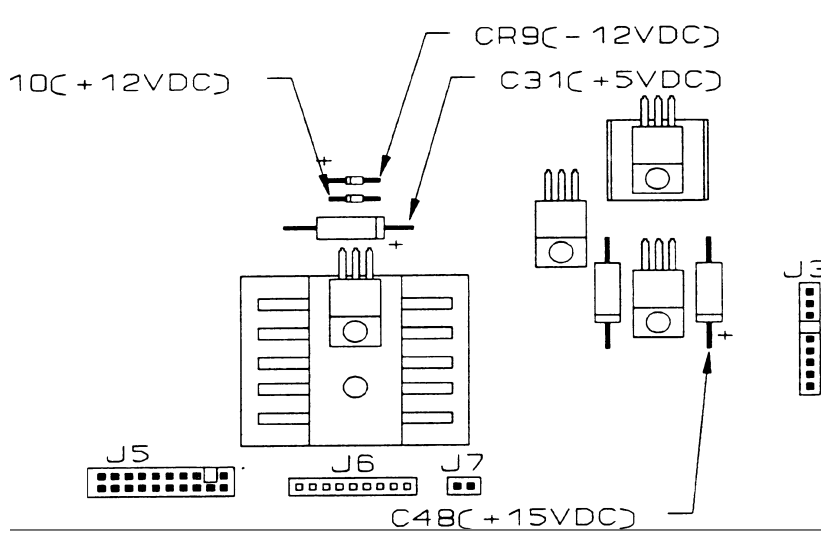

Figure 7-1: Main PCB DC Voltage Checks

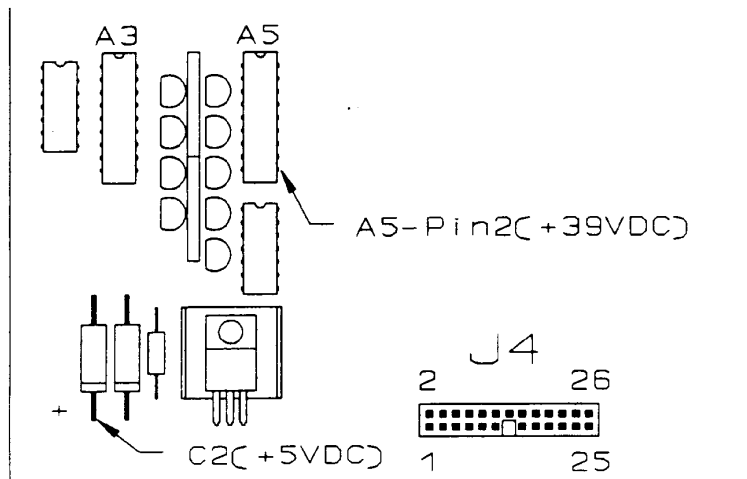

Figure 7-2: Main PCB Display Voltage Checks

7.3.2. Dual Display PCB DC Voltage Checks

All DC voltages listed are referenced to chassis ground (minus meter lead to chassis ground). Refer to Figure 6-2 in Section 6.1.2. for connector locations and Figures 7-3 and 7-4 for component locations.

If any of the listed DC voltages are not present or are out of specification then check the AC transformer voltage listed in Section 7.3.3.

Voltage	Description	Acceptable Voltage		Maximum AC Ripple	Plus Meter Lead	Notes
		Minimum	Maximum			
+10 VDC	Raw +5 Supply	+8	+12	0.3	J6-2	1
+5 VDC	+5 Main PCB	+4.75	+5.25	0.02	Q5-2	2
+5 VDC	+5 Display PCB	+4.75	+5.25	0.02	Q1-2	3
+22 VDC	+ Raw Supply	+17	+25	0.5	JN-15	4
-22 VDC	- Raw Supply	-17	-25	0.5	JN-17	5
+12 VDC	+ RS-232 Supply	+11.5	+12.5	0.02	Q7-2	6
-12 VDC	- RS-232 Supply	-11.5	-12.5	0.02	Q6-2	7
+39 VDC	Display Supply	+32.5	+40.5	0.75	A1-10	8

Table 7-4: Dual Display PCB DC Voltage Checks

Dual Display Voltage Check Notes:

- 1 - **+10 VDC**: Raw +5 VDC logic supply, (connector J6, pin 2).
- 2 - **+5 VDC**: Regulated control logic supply, (Q5 pin 2, Figure 7-3).
- 3 - **+5 VDC**: Regulated display logic supply, (Q1 pin 2, Figure 7-3).
- 4 - **+22 VDC**: JW port 20 mA current loop + supply, raw +12 VDC supply and raw +39 VDC supply, (connector JN, pin 15 or Wall unit JN pin R).
- 5 - **-22 VDC**: JW port 20 mA current loop - supply, raw supply for -12 VDC, (connector JN, pin 17 or wall unit JN pin T).
- 6 - **+12 VDC**: JW and JY Port RS-232 Supply, (Q7 pin 2, Figure 7-1).
- 7 - **-12 VDC**: JW and JY Port RS-232 Supply, (Q6 pin 2, Figure 7-3).
- 8 - **+39 VDC**: Display Voltage (A1 pin 10, Figure 7-4).

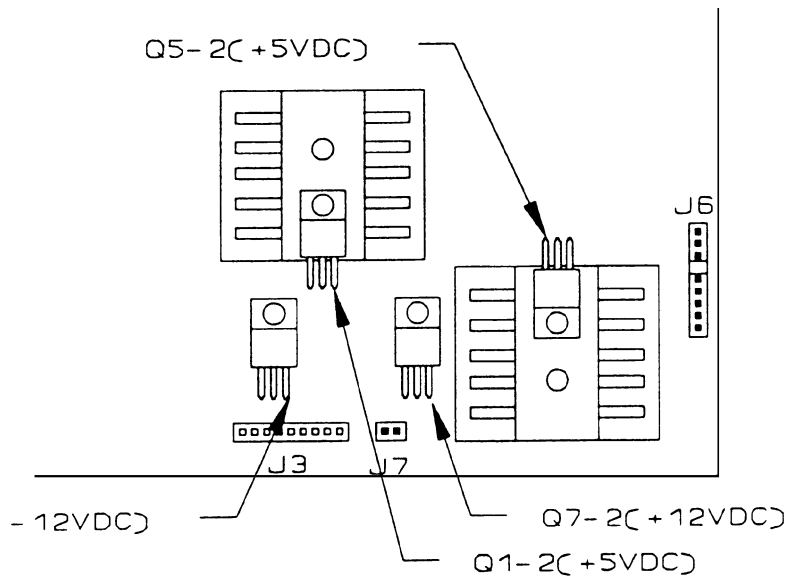

Figure 7-3: Dual Display PCB DC Voltage Checks

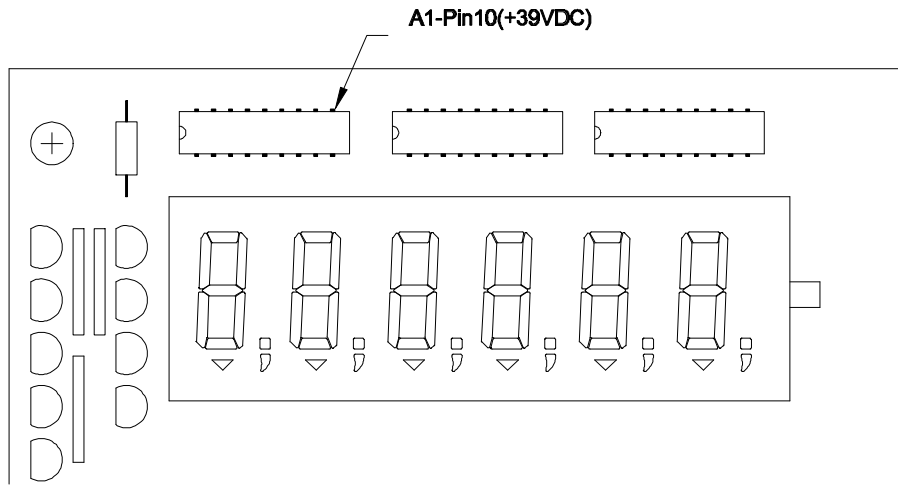

Figure 7-4: Dual Display PCB Display Voltage Check

7.3.3. AC Transformer Voltages

If any of the DC power supply voltages listed in Sections 7.3.1. or 7.3.2. are missing or out of specification then check the AC transformer voltages listed next. Refer to Figure 7-5.

Voltage	Acceptable Voltage		Plus Meter Lead	Minus Meter Lead	Notes
	Minimum	Maximum			
19 VAC	17	22	J3-7	J3-9	1&4
19 VAC	17	22	J3-8	J3-9	2&4
9 VAC	7.5	11	CR1-AC	CR1-AC	3&4
37.7VAC	36.8	38.6	J3-7	J3-8	4
18.8VAC	18.4	19.3	J6-5	J6-6	4

Table 7-5: Transformer AC Voltage Checks

Transformer AC Voltage Checks Notes:

- 1 - 19 VAC: Raw AC supply for the ± 22 VDC supply on the Main PCB.
- 2 - 19 VAC: Raw AC supply for the ± 22 VDC supply on the Main PCB and the +39 VDC supply on the Dual Display PCB.
- 3 - 9 VAC: Raw AC supply for the +10 VDC Supply for both the Main and Dual Display PCBs. Disconnect the red leads from the bridge rectifier CR1 and measure the AC voltage from 1 red lead to the other.
- 4 - These voltages are the limits for a 120 VAC power line. They will vary with the AC input and are acceptable from -15% to +10% corresponding to a 120 VAC up to a 132VAC power line.

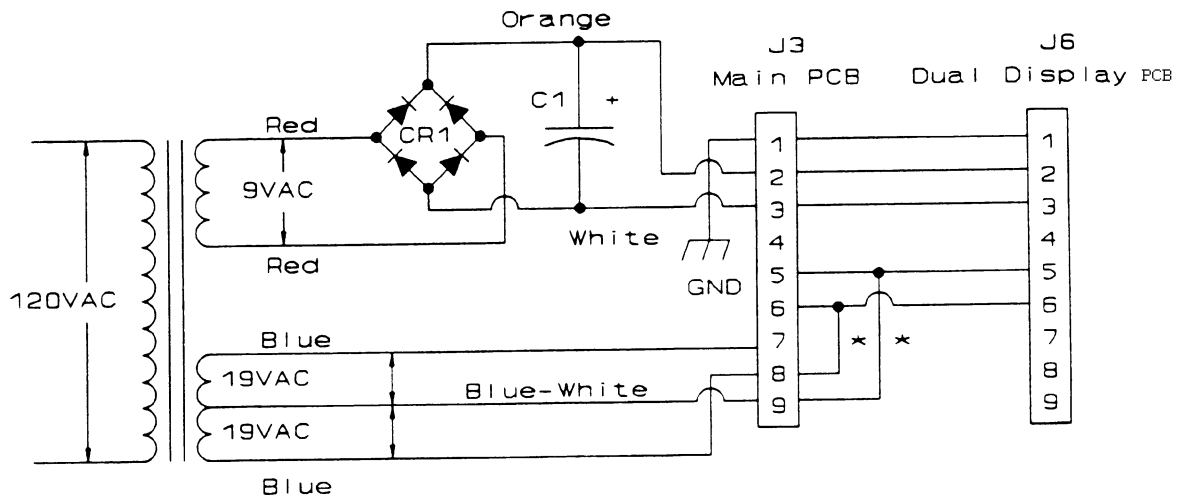

Figure 7-5: AC Voltage Checks
 (*) Jumper wires shown are located in the Main PCB

8. SPARE PARTS AND ACCESSORIES

8.1. Spare Parts

It is recommended that the spare parts listed be stocked in order to minimize downtime in the event of a malfunction. Parts listed are available through your local, authorized Toledo Scale representative.

The 8142 parts catalog PC008142 I03, is also recommended so that items not listed may be properly identified for correct and prompt delivery.

Part Description	Desk: 8142-0007	Wall: 8142-1007	Rack: 8142-2007
Keyboard Assembly	125821 00A	125824 00A	125827 00A
Main PCB	128894 00A	128894 00A	128903 00A
Display PCB	N.A.	N.A.	121641 00A
0.5 A Slo-Blo Fuse	112145 00A	N.A.	112145 00A

Spare Parts, Single Display Versions

Part Description	Desk: 8142-0008	Wall: 8142-1008	Rack: 8142-2008
Keyboard Assembly	125822 00A	125825 00A	125828 00A
Main PCB	128897 00A	128897 00A	128897 00A
Dual Display PCB	125845 00A	125845 00A	125846 00A
Display PCB	N.A.	N.A.	121642 00A
0.5 A Slo-Blo Fuse	112145 00A	N.A.	112145 00A

Spare Parts, Dual Display Versions

Part Description	Desk: 8142-0009	Wall: 8142-1009	Rack: 8142-2009
Keyboard Assembly	125823 00A	125826 00A	125829 00A
Main PCB	128900 00A	128900 00A	128900 00A
Dual Display PCB	125854 00A	125854 00A	125855 00A
Display PCB	N.A.	N.A.	121642 00A
0.5 A Slo-Blo Fuse	112145 00A	N.A.	112145 00A

Spare Parts, Dual Display Advanced Versions

Note(S): Part numbers listed may have a letter prefix.
(N.A.) Means not applicable.

8.2. Cables and Mating Connectors

To remove wall version connectors press the connector in toward the enclosure and twist the connector counterclockwise. BCD/Analog cables listed, include the mating connector.

Part numbers listed may include a letter prefix.

8.2.1. Desk and Rack Versions Mating Connectors

Connector	Description	Part Number	Factory Number
Load Cell: J1	Connector KOP	125819 00A	0917-0117
Serial I/O: JN, JW, JY	Connector	107187 00A	0917-0144
	Shell	125389 00A	
	Pins (10)	107189 00A	
	Grommet	125842 00A	
BCD/Analog	Connector 25' Cable	124851 00A KA568949	N.A.

Note: BCD/Analog Connector for use with Rack versions only.

8.2.2. Wall Versions Mating Connectors

Connector	Description	Part Number	Factory Number
Load Cell: J1	Connector	125820 00A	0917-0118
Serial, JN Serial, JW Serial, JY	Connector KOP	126232 00A	0917-0121
	Connector	123480 00A	0917-0138
	Connector	123482 00A	0917-0143
BCD/Analog	Connector	126274 00A	0917-0106
	25' Cable	126242 00A	0917-0179

Note: Wall mount connectors require cleaning and potting KOPs, refer to Section 8.3.

8.2.3. Printer Interconnect Cables.

Printer Model	Enclosure/Cable Length	Part Number	Factory Number
307	Desk/Rack 6'	119714 00A	0900-0191
	Desk/Rack 20'	119715 00A	0900-0199
	Wall 6'	122570 00A	0900-0180
	Wall 20'	122571 00A	0900-0181
8806 8860D	Desk/Rack 6'	115544 00A	0900-0136
	Desk/Rack 20'	115545 00A	0900-0137
	Wall 6'	122574 00A	0900-0188
	Wall 20'	122575 00A	0900-0189
8843	Desk/Rack 6'	128220 00A	0900-0214
	Wall 20'	128221 00A	0900-0215
8855	Desk/Rack 6'	119722 00A	0900-0197
	Desk/Rack 20'	119723 00A	0900-0198
	Wall 6'	122578 00A	0900-0186
	Wall 20'	122579 00A	0900-0187
8860WD	Wall 25'	125058 00A	0900-0293

Note: Adapter plug included with 8860D (Desk Version) must be used.

8.3. Optional Kits Of Parts (KOP)

8.3.1. Desk Versions KOPs

KOP Description	Part Number	Factory Number
Base Mounting Plate	124159 00A	0901-0178
RFI Protection	125347 00A	0917-0110
Remote Gross, Tare, Print (8142-0008 Only)	125802 00A	0917-0113
JY Port Host Communication (8142-0009 Only)	125803 00A	0917-0114

8.3.2. Wall Versions KOPs

KOP Description	Part Number	Factory Number
BCD/Analog Output (8142-1009 Only)	123503 00A	0917-0104
RFI Protection	133132 00A	0917-0182
Remote Gross, Tare, Print (8142-1008 Only)	125804 00A	0917-0115
JY Port Host Communication (8142-1009 Only)	125805 00A	0917-0116
Connector Potting	125839 00A	0901-0194
Connector Potting Refill	125874 00A	0901-0195
Connector Cleaning	125875 00A	0901-0196
Load Cell Connector Quick Disconnect	133144 00A	0917-0186

8.3.3. Rack Versions KOPs

KOP Description	Part Number	Factory Number
Panel Mount	106299 00A	0917-0005
BCD/Analog Output (8142-2009 Only)	123504 00A	0917-0105
RFI Protection	125349 00A	0917-0112
Remote Gross, Tare, Print (8142-2008 Only)	125802 00A	0917-0113
JY Port Host Communication (8142-2009 Only)	125803 00A	0917-0114

9. INDEX

- AC Power Voltage Selection 9
- Agency Approval
 - U.L. 6
 - CSA 6
 - FCC 6
 - NEMA 6
 - NTEP 6, 44
- Analog Verify 26
- Appearance 6
- ACSII Input 2, 3, 8, 32, 70
- Auto Clear Tare 18
- Auto Print 32, 33
- AZM (Auto Zero Maintenance) 24, 25
- Baud Rate 27, 37, 39
- BCD/Analog Output 40, 95
- Calibration 44-47
 - Decimal Point Location 1, 42, 53-55
 - Error Codes 101
 - Increment Size 1, 42
 - Linearity Compensation 2, 43, 44
 - Short Cut Calibration 46,
 - Span Calibration Range 47
 - Total Number of Increments 1, 42
 - Zero Calibration Range 1
- Checksum 27, 38, 39
- Clock Adjust 2, 34
- Connectors
 - BCD/Analog Pinout 95
 - Connector Location 58-59
 - Load Cell Pinout 61-62
 - JN Port Pinout 70
 - JW Port Pinout 76
 - JY Port Pinout 82
 - Mating Connectors 109
- Consecutive Numbering 2, 16, 34
- Continuous Mode Output 8, 74, 80, 82-84
- Demand Mode Output 8, 73
- Digital Filtering 25
- Display 1-3, 7, 50-51
- Enclosure Dimensions 6,7
- Error Codes 101-102
- Expanded Weight Display 23
- Factory Number Configuration 4
- Hazardous Areas 5
- ID (Numeric Identification) 2, 31, 34, 51
- Installation 9-48
- Interconnect Diagrams 114-116
- Keyboard 1, 16, 52-54
 - Enter Key 16, 53-54
 - Numeric Keys 16, 53-54
 - Setup Key 16, 53-54
 - Tare Key 16, 53-54
 - Zero Key 16, 53-54
- Keystroke Timeout 22
- Linearity Compensation 2, 43, 44
- Load Cell
 - Cable Termination 63-68
 - Excitation Supply Voltage 1, 102-107
 - Junction Boxes 60-62
- Maintenance 100
- Minimum Print 28, 32
- Motion Detect Range 25
- Motion Detect Window 25
- Net Sign Corrected Print 31
- Opening Enclosures 9-10, 48
- Operation 50-54
- Operational Error codes 101
- Optional KOP (Kit Of Parts) 111
- Overload Display Blanking 43

PCB Jumper Descriptions 58-60

Power Requirements 5, 14

Power Supply Voltage Checks 102-107

Power Transformer 5

Power-up Sequence 56

Power-up Timer 23

Power-up Weight Units 23

Preliminary Calculations 13-14
 Microvolt Per Increment 13-14
 Total Number of Increments 13-14
 Microvolt Build Table 13-14

Printer Cables 109

Print Interlock 32-33

Remote Contact Closure Input
 Clear 78
 Print 72,79
 Tare 78

RFI (Radio Frequency Interference) 6, 14

Serial JN Printer Port 2-3, 8, 70-76
 Data Format 32, 70-76
 Setup 26-33

Serial JW Setpoint Port 3, 8, 76-81
 Data Format 72-73
 Setup 36-38

Serial JY Host Port 3, 8, 82-93
 Data Format 82-93
 Scale Address 39, 83
 Setup 38-39

Setpoints 3, 8, 89-90
 Data Input 54-56
 Installation Precautions 13, 79
 Setup 35-36
 TTL Output 79

Setup Mode 16-48
 Accessing 16
 Exiting 48
 Key Functions 16
 Parameter Print Out 2-3, 17
 Quick Reference Chart 18-20

Shipping Weight 6

Span Adjust 47

Spare Parts 109-111

Static Electricity 15

Tare 21

Tare Interlocks 21

Temperature Range 5

Time and Date 2, 17

Troubleshooting 100

Under Zero Display 24

Washdown Enclosure 5, 48

Weight Units Switching 26

Zero Key 1, 26

Zero Reference Adjust 24

10. INTERCONNECT DRAWING

10.1. Single Display Versions

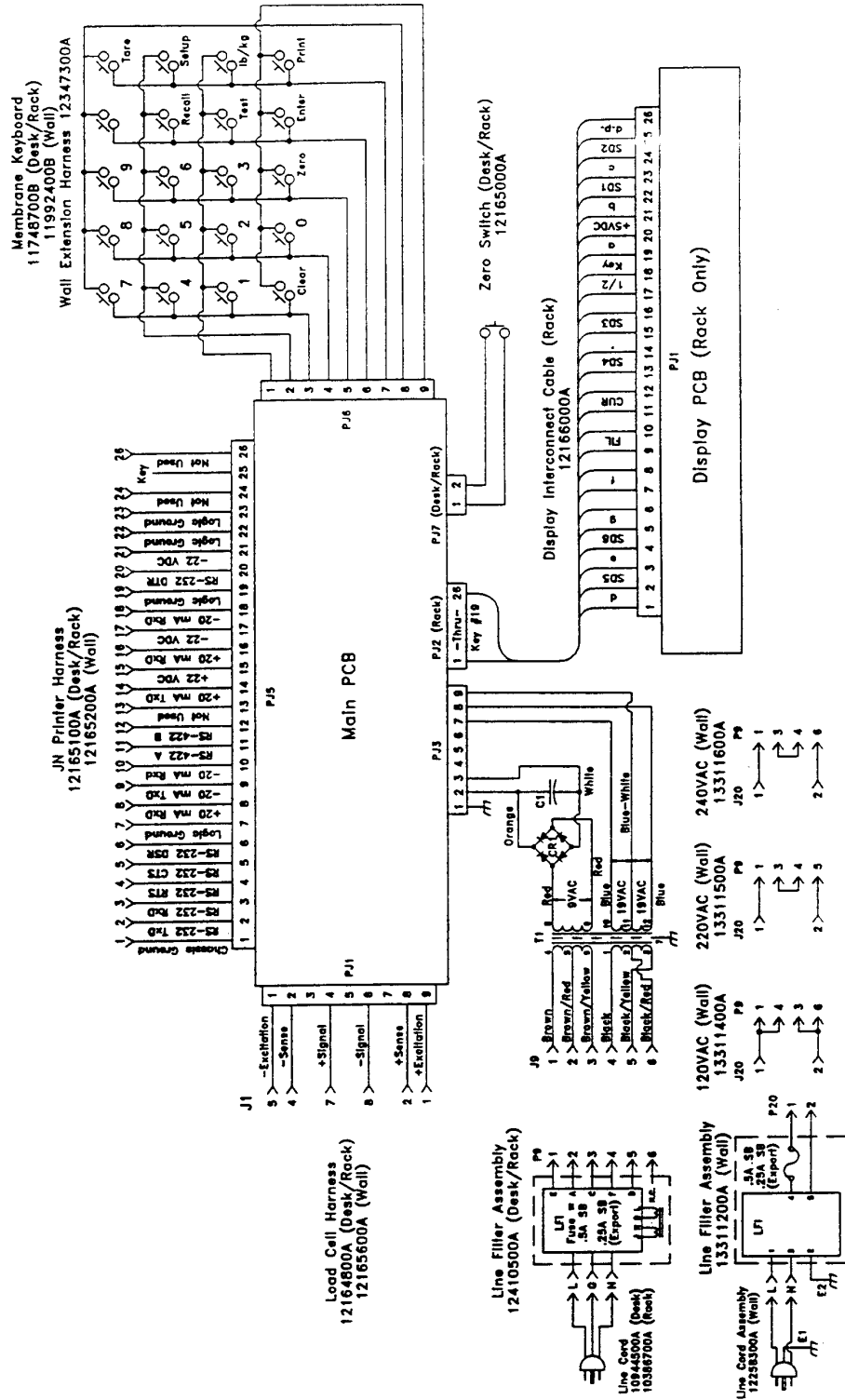

10.2. Dual Display and Dual Display Advanced Versions

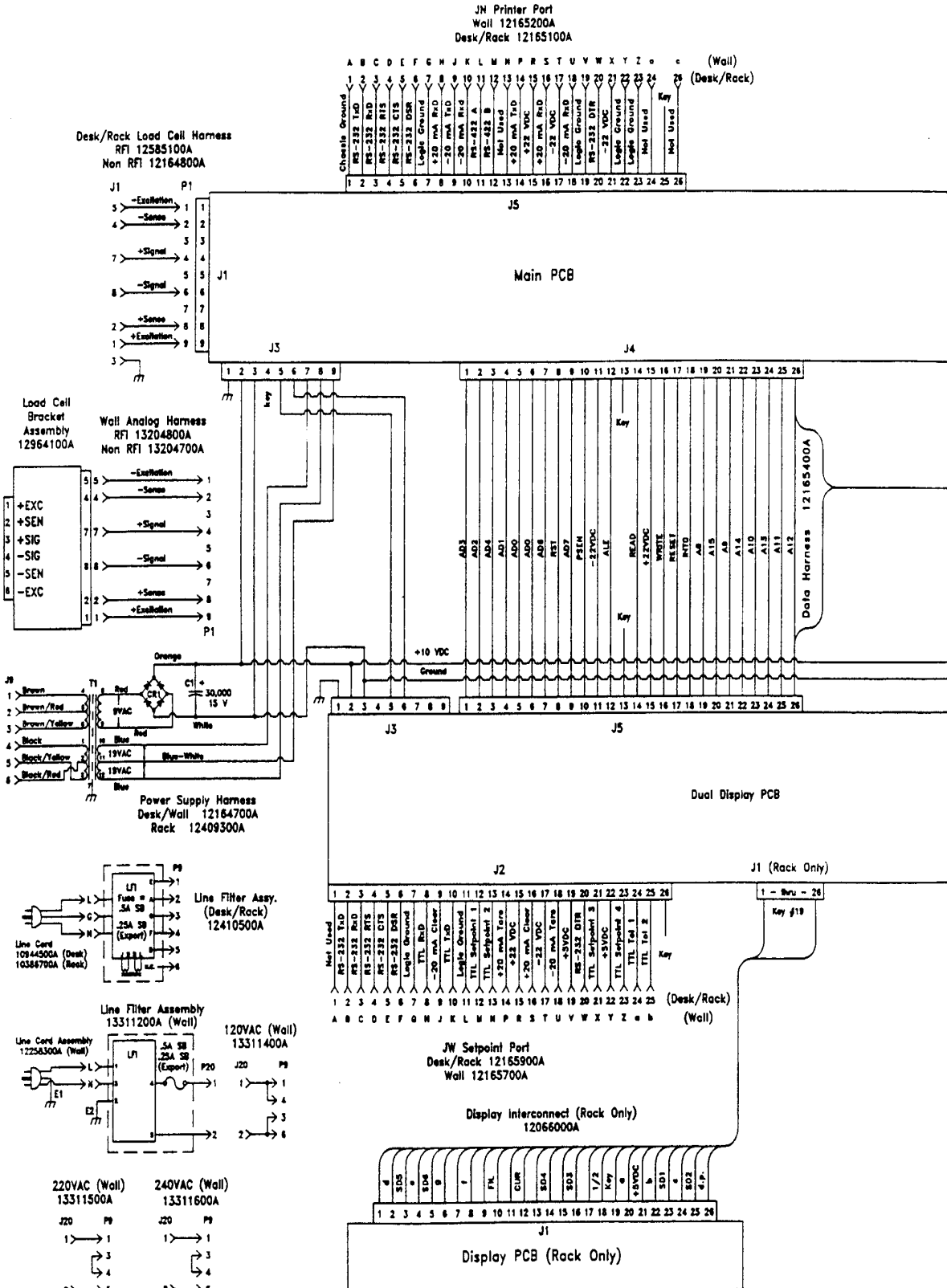

J2 ECU/Analog Output Option
 0917-0104 (Wall)
 0917-0105 (Rack)

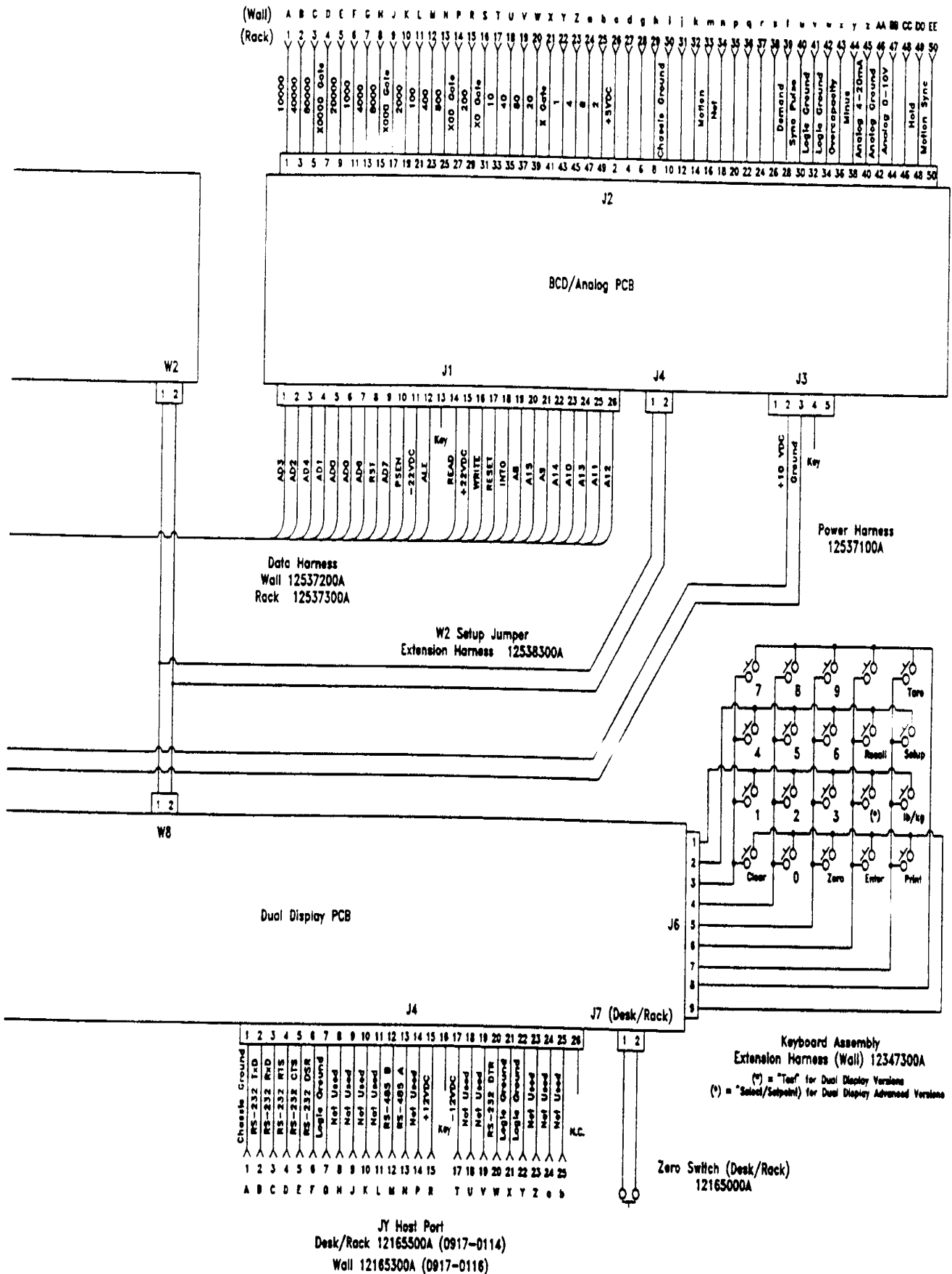

(Wall)	A	B	C	D	E	F	G	H	J	K	L	M	N	P	R	S	T	U	V	W	X	Y	Z	a	b	c	d	e	f	g	h	i	j	k	m	p	q	r	s	t	u	v	w	x	y	z	AA	BB	CC	DD	EE
(Rack)	10000	40000	80000	X0000 Gate	20000	1000	4000	8000	X1000 Gate	2000	100	400	800	X00 Gate	200	X0 Gate	10	40	80	20	X Gate	1	4	8	2	+5VDC	Chassis Ground	Motion	Hold	Demand	Syna Pulse	Logic Ground	Logic Ground	Overcapacity	Minus	Analog 4-20mA	Analog Ground	Analog 0-10V	Hold	Motion Sync											

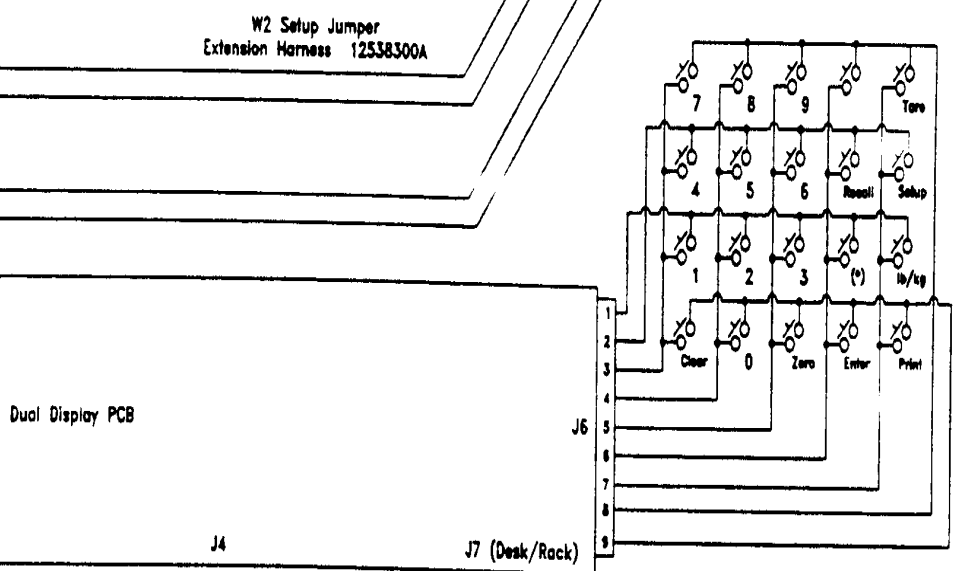
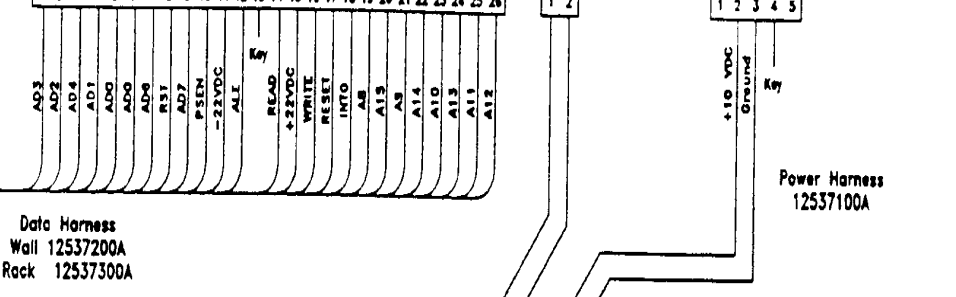
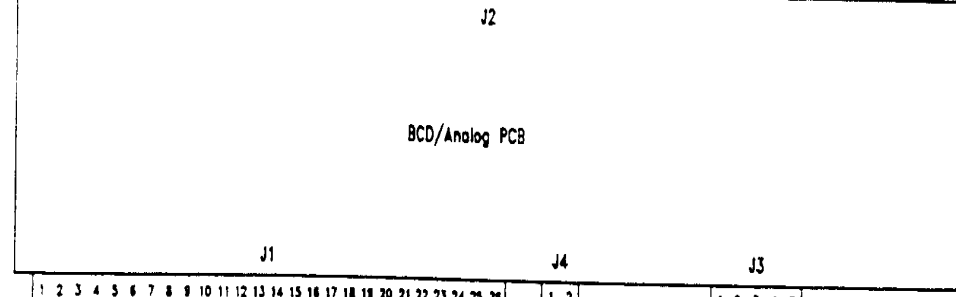

1	2	3	4	5	6	7	8	9	10	11	12	13	14	15	16	17	18	19	20	21	22	23	24	25
Chassis Ground	RS-232 InD	RS-232 RxD	RS-232 RTS	RS-232 CTS	Logic Ground	Not Used	Not Used	Not Used	RS-485 A	RS-485 B	Not Used	+12VDC	Key	-12VDC	Not Used	Not Used	RS-232 DTR	Logic Ground	Not Used	Not Used	Not Used	N.C.		
A	B	C	D	E	F	G	H	J	K	L	M	N	P	T	U	V	W	X	Y	Z	a	b		

JY Host Port
 Desk/Rack 12165500A (0917-0114)
 Wall 12165300A (0917-0116)

-For Your Notes -

Mettler-Toledo Inc.
Scales & Systems
350 W. Wilson Bridge Road
Worthington, Ohio 43085
(614) 438-4511

P/N E125377 00A

Printed in USA 12/96

© 1996 Mettler-Toledo Inc.



E12537700A