

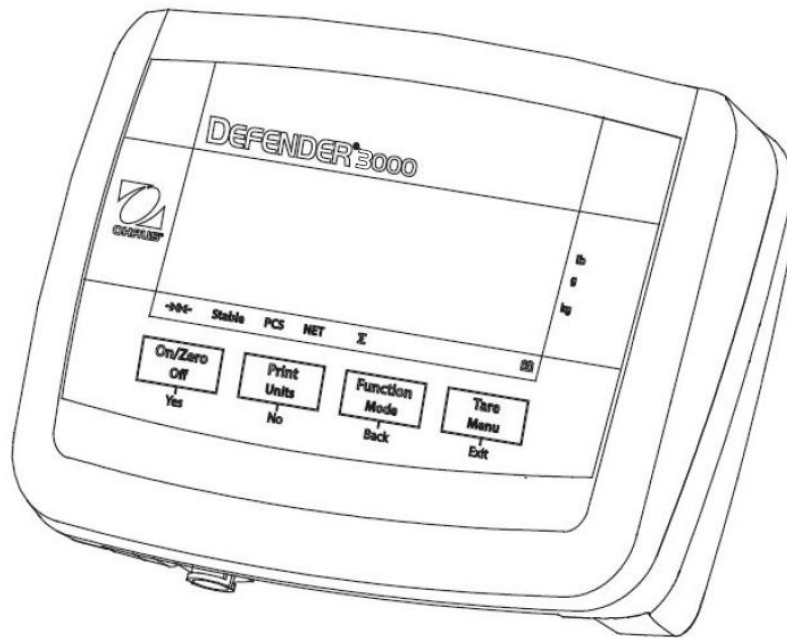

3000 Series Indicators

Instruction Manual



TD32PE Indicator

TABLE OF CONTENTS

1. INTRODUCTION.....	EN-4
1.1 Definition of Signal Warnings and Symbols.....	EN-4
1.2 Safety Precautions	EN-4
1.3 Overview of Parts and Controls	EN-5
1.4 Control Functions.....	EN-8
2. INSTALLATION	EN-9
2.1 Unpacking	EN-9
2.2 External Connections.....	EN-9
2.2.1 Scale Base to Indicator	EN-9
2.2.2 AC Power to Indicator	EN-9
2.2.3 Battery power to Indicator	EN-10
2.2.4 RS232 Interface Cable to Indicator (Optional).....	EN-10
2.3 Internal Connections.....	EN-11
2.3.1 Opening the Housing.....	EN-11
2.3.2 Jumper Connections	EN-11
3. SETTINGS.....	EN-12
3.1 Menu Structure	EN-12
3.2 Menu Navigation	EN-13
3.3 Calibration Menu	EN-13
3.3.1 Zero Calibration	EN-13
3.3.2 Span Calibration.....	EN-14
3.3.3 Linearity Calibration	EN-14
3.3.4 Geographical Adjustment Factor	EN-15
3.3.5 End Calibration.....	EN-15
3.4 Setup Menu.....	EN-17
3.4.1 Reset.....	EN-17
3.4.2 Capacity	EN-17
3.4.3 Graduation.....	EN-19
3.4.4 Power On Unit	EN-19
3.4.5 Zero Range	EN-19
3.4.6 End Setup	EN-19

TABLE OF CONTENTS (Cont.)

3.5	Readout Menu	EN-19
3.5.1	Reset	EN-19
3.5.2	Stable Range	EN-20
3.5.3	Filter	EN-20
3.5.4	Auto-Zero Tracking	EN-20
3.5.5	Sleep	EN-20
3.5.6	Light	EN-20
3.5.7	Auto Off	EN-20
3.5.8	Expand	EN-20
3.5.9	End Readout	EN-20
3.6	Mode Menu	EN-21
3.6.1	Reset	EN-21
3.6.2	Parts Counting Mode	EN-21
3.6.3	End Mode	EN-21
3.7	Unit Menu	EN-21
3.7.1	Reset	EN-21
3.7.2	Kilogram Unit	EN-21
3.7.3	Gram Unit	EN-21
3.7.4	Pound Unit	EN-22
3.7.5	End Unit	EN-22
3.8	Print Menu	EN-22
3.8.1	Reset	EN-22
3.8.2	Baud	EN-22
3.8.3	Parity	EN-22
3.8.4	Stop Bit	EN-23
3.8.5	Handshake	EN-23
3.8.6	Stable Only	EN-23
3.8.7	Auto Print	EN-23
3.8.8	Content	EN-23
3.8.9	Layout	EN-24
3.8.10	End Print	EN-24

TABLE OF CONTENTS (Cont.)

3.9 Security Switch	EN-25
4. OPERATION	EN-25
4.1 Turning Indicator On/Off	EN-25
4.2 Zero Operation	EN-25
4.3 Manual Tare	EN-25
4.4 Changing Units of Measure	EN-26
4.5 Printing Data	EN-26
4.6 Application Modes	EN-26
4.6.1 Weighing	EN-26
4.6.2 Parts Counting	EN-26
4.6.3 Totalization	EN-27
5. SERIAL COMMUNICATION	EN-28
5.1 Interface Commands	EN-28
5.2 Output Format	EN-28
5.3 Printout Examples	EN-29
6. LEGAL FOR TRADE	EN-30
6.1 Settings	EN-30
6.2 Verification	EN-30
7. MAINTENANCE	EN-31
7.1 Cleaning	EN-31
7.2 Troubleshooting	EN-31
7.3 Service Information	EN-31
8. TECHNICAL DATA	EN-31
8.1 Specifications	EN-31
8.2 Accessories	EN-32
8.3 Drawings and Dimensions	EN-33
8.4 Compliance	EN-34

1. INTRODUCTION

This manual contains installation, operation and maintenance instructions for the TD32PE indicator. Please read this manual completely before installation and operation.

1.1 Definition of Signal Warnings and Symbols

Safety notes are marked with signal words and warning symbols. These show safety issues and warnings. Ignoring the safety notes may lead to personal injury, damage to the instrument, malfunctions and false results.

Signal Words

CAUTION	For a hazardous situation with low risk, resulting in damage to the device or the property or in loss of data, or injuries if not avoided.
Attention	For important information about the product
Note	For useful information about the product

Warning Symbols



General Hazard



Electrical Shock Hazard

1.2 Safety Precautions



For safe and dependable operation of this equipment, please comply with the following safety precautions:

- Verify that the AC adapter's input voltage range and plug type are compatible with the local AC power to be used.
- Make sure that the power cord does not pose a potential obstacle or tripping hazard.
- Do not position the indicator such that it is difficult to reach the power connection.
- The indicator is for indoor use only.
- Use the indicator only in dry locations.
- Use only approved accessories and peripherals.
- Operate the equipment only under ambient conditions specified in these instructions.
- Disconnect the equipment from the power supply before cleaning.
- Do not operate the equipment in hazardous or unstable environments.

1.3 Overview of Parts and Controls

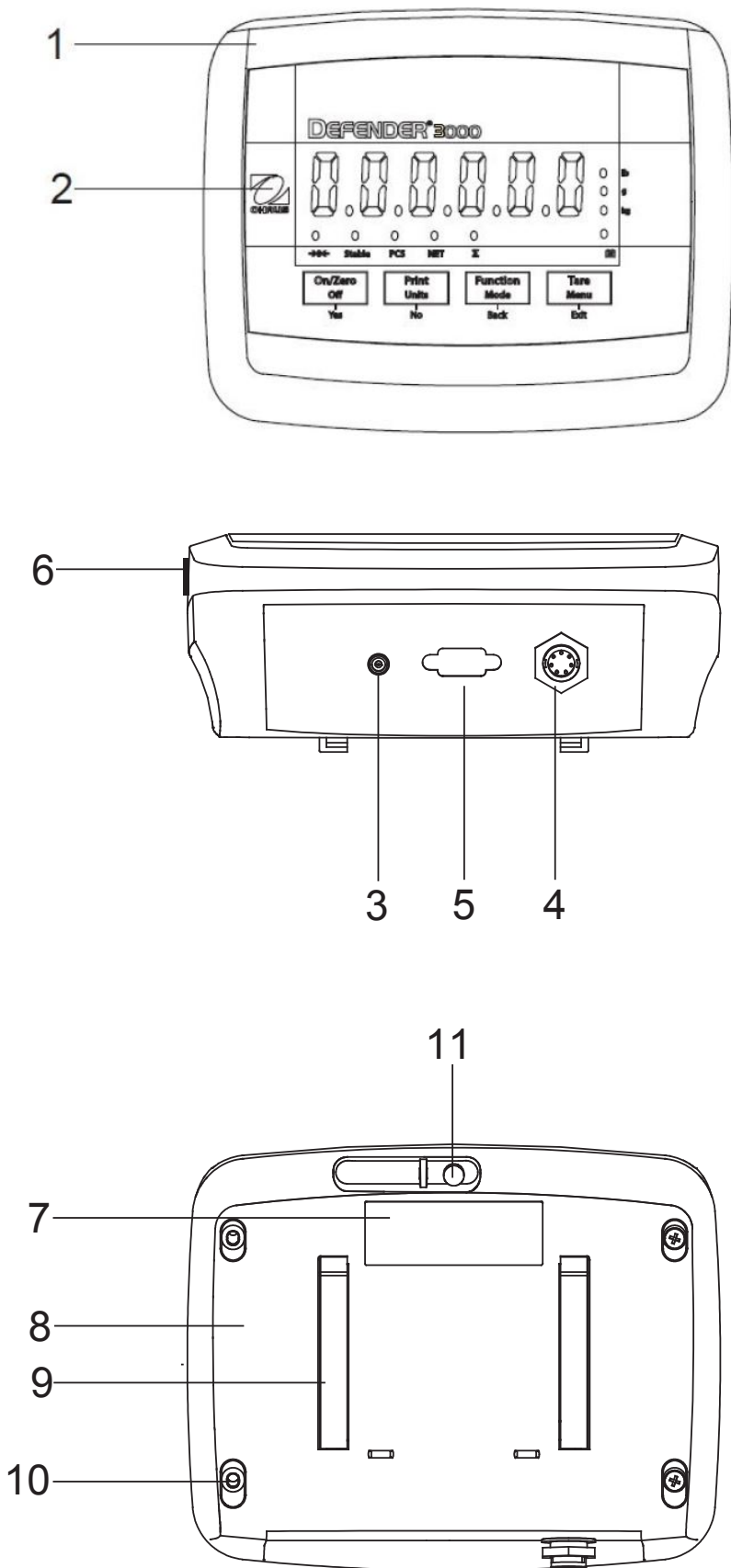

TABLE 1-1. TD32PE PARTS.

Item	Description
1	Front Housing
2	Control Panel
3	Power Receptacle
4	Load Cell Cable Connector
5	RS232 Connector (optional)
6	Data Label
7	FCC Information
8	Rear Housing
9	Mounting Track
10	Screw (4)
11	Security Screw

Figure 1-1. TD32PE Indicator.

1.3 Overview of Parts and Controls (Cont.)

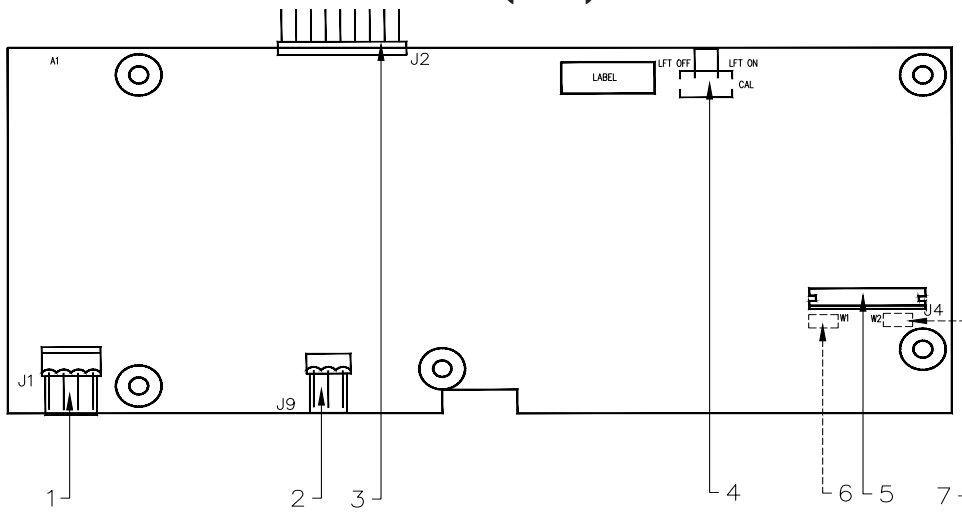

Figure 1-2. Main PC Board.

TABLE 1-2. MAIN PC BOARD.

Item	Description
1	Power Connector J1
2	Battery Connector J9
3	Option Connector J2
4	LFT Switch
5	4-6 Lines Sense Jumper W1 (located on the other side of PCB)
6	Load Cell Connector J4
7	4-6 Lines Sense Jumper W2 (located on the other side of PCB)

1.3 Overview of Parts and Controls (Cont.)

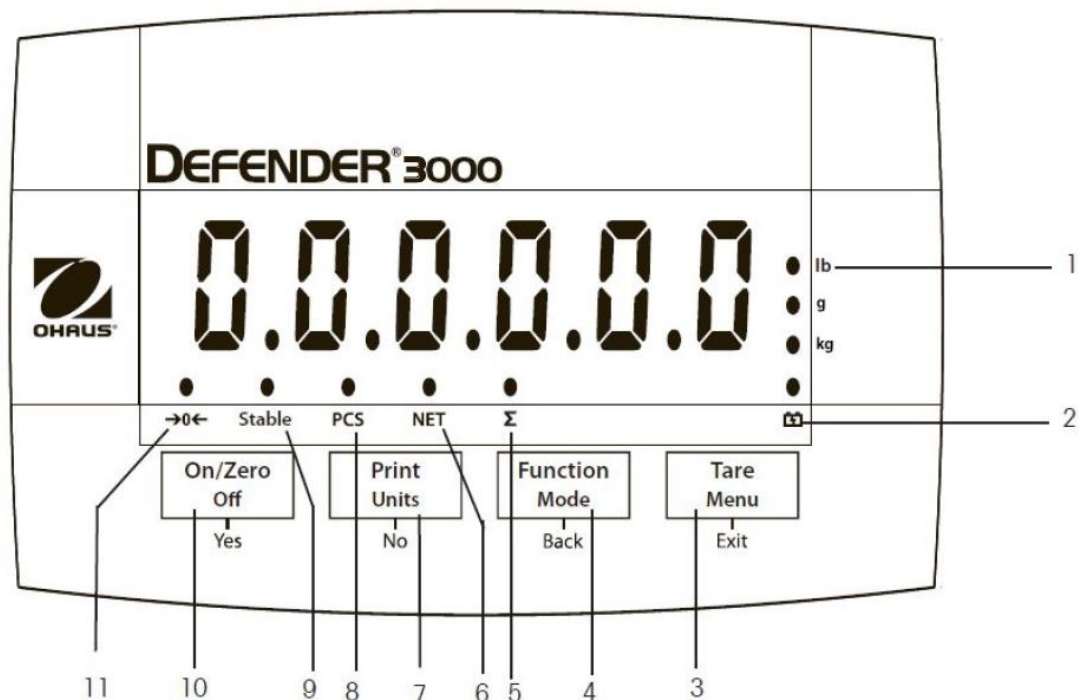

Figure 1-3. Controls and Indicators.

TABLE 1-3. CONTROL PANEL.

No.	Designation
1	Pound, Kilogram, Gram symbols
2	Battery function symbol
3	TARE <i>Menu</i> button
4	FUNCTION <i>Mode</i> button
5	Accumulation Symbol
6	NET function symbol
7	PRINT <i>Units</i> button
8	PCS function symbol
9	Stable weight Symbol
10	ON/ZERO <i>Off</i> button
11	Center of Zero Indicator

1.4 Control Functions

TABLE 1-4. CONTROL FUNCTIONS.

Button	<div style="border: 1px solid black; padding: 5px; text-align: center;"> On/Zero Off Yes </div>	<div style="border: 1px solid black; padding: 5px; text-align: center;"> Print Units No </div>	<div style="border: 1px solid black; padding: 5px; text-align: center;"> Function Mode Back </div>	<div style="border: 1px solid black; padding: 5px; text-align: center;"> Tare Menu Exit </div>
Primary Function (Short Press)	ON/ZERO If Indicator is On, sets zero.	PRINT Sends the current value to the COM port if AUTOPRINT is set to Off.	FUNCTION Initiates an application mode.	TARE Performs a tare operation.
Secondary Function (Long Press)	Off Turns the Indicator on or off.	Units Changes the weighing Unit.	Mode Allows changing the application mode. Press and hold allows scrolling through modes.	Menu Enter the User menu.
Menu Function (Short Press)	Yes Accepts the current setting on the display.	No Advances to the next menu or menu item. Rejects the current setting on the display and advances to the next available setting. Increments the value.	Back Moves Back to previous menu item. Decrements the value.	Exit Exits the User menu. Aborts the calibration in progress.

2. INSTALLATION

2.1 Unpacking

Unpack the following items:

- Indicator
- AC Adapter
- Column Connector
- Instruction Manual
- Load Cell Connector

2.2 External Connections

2.2.1 Scale Base to Indicator

Connect the load cell cable to the indicator as shown below:

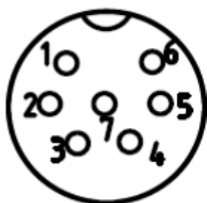

Pin	Connection
1	+EXE
2	+SEN
3	+SIG
4	GND
5	-SIG
6	-SEN
7	-EXE

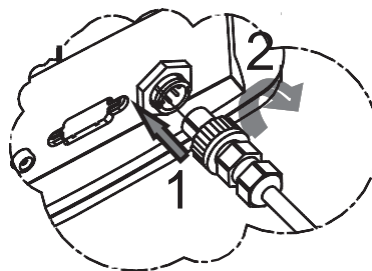

Note: To connect TD32PE to other bases, a loadcell connector needs to be soldered as shown above.

2.2.2 AC Power to Indicator

Connect the AC Adapter to the power receptacle (Figure 1-1, item 3), then plug the AC Adapter into an electrical outlet.

2.2.3 Battery Power

The indicator can be operated on the internal rechargeable battery when AC power is not available. The indicator will automatically switch to battery operation if there is a power failure or the power cord is removed.



Attention:

Before using the indicator for the first time, the internal rechargeable battery should be fully charged for up to 12 hours. The indicator can be operated during the charging process. The battery is protected against over charging and the indicator can remain connected to the AC power line.

Connect AC power to the indicator and allow it to charge. While the battery is charging, the triangle above the battery function symbol will light. When the battery is fully charged, this triangle will disappear.

The indicator can operate for up to 80 hours on a fully charged battery.

During battery operation, a flashing triangle above the battery function symbol indicates the battery is low and requires recharging. Approximately 30 minutes of operation will remain when the battery symbol starts to blink. The indicator will display Lo.BAT and automatically turn off when the battery is fully discharged.

CAUTION

BATTERY IS TO BE REPLACED ONLY BY AN AUTHORIZED OHAUS SERVICE DEALER.

RISK OF EXPLOSION CAN OCCUR IF REPLACED WITH THE WRONG TYPE OR CONNECTED IMPROPERLY.



Dispose of the lead acid battery according to local laws and regulations.

2.2.4 RS232 interface Cable to Indicator (Optional)

Connect the optional RS232 cable to the RS232 connector Figure 1-1, item 5.

Note: For installation instructions, please refer to optional RS232 user manual.

Pin	Connection
1	N/C
2	TXD
3	RXD
4	N/C
5	GND
6	N/C
7	N/C
8	N/C
9	N/C

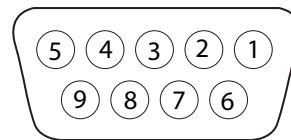

Figure 2-1. RS232 Pins.

2.3 Internal Connections

Some connections require the housing to be opened.

2.3.1 Opening the Housing



CAUTION: ELECTRICAL SHOCK HAZARD. REMOVE ALL POWER CONNECTIONS TO THE INDICATOR BEFORE SERVICING OR MAKING INTERNAL CONNECTIONS. THE HOUSING SHOULD ONLY BE OPENED BY AUTHORIZED AND QUALIFIED PERSONNEL, SUCH AS AN ELECTRICAL TECHNICIAN.

Remove the four Phillips head screws from the rear housing.
Open the housing being careful not to disturb the internal connections.
Once all connections are made, reattach the front housing.

2.3.2 Jumper Connections

For a 4-wire load cell with no sense wires: Jumpers W1 and W2 must be shorted.
For a 6-wire load cell that includes sense wires, Jumpers W1 and W2 must be opened.

Note: 6-wire load cell setting is default.

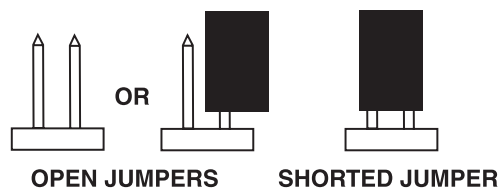

Figure 2-2. Jumper Connections.

After wiring is completed and jumpers are in place, replace the indicator housing screws.

3 SETTINGS

3.1 Menu Structure

TABLE 3-1. MENU STRUCTURE.

CALIBRATION	→ SETUP	→ READOUT	→ MODE	→ UNIT	→ PRINT	→ END
↳ Zero	↳ RESET	↳ RESET	↳ RESET	↳ RESET	↳ RESET	
↳ SPAN	↳ NO	↳ NO	↳ NO	↳ NO	↳ NO	
↳ LINEARITY	↳ YES	↳ YES	↳ YES	↳ YES	↳ YES	
↳ GEO	↳ CAPACITY	↳ STABLE RANGE	↳ COUNT	↳ KILOGRAM	↳ BAUD	
↳ 00...31	↳ 5...20000	↳ 0.5d	↳ OFF	↳ OFF	↳ 300, ...19200	
↳ END CAL	↳ GRADUATION	↳ 1d	↳ ON	↳ ON	↳ PARITY	
	↳ 0.001...20	↳ 2d	↳ TOTALIZE	↳ GRAM	↳ 7 EVEN	
	↳ POWER ON UNIT	↳ 5d	↳ OFF	↳ OFF	↳ 7 ODD	
	↳ AUTO	↳ FILTER	↳ ON	↳ ON	↳ 7 NONE	
	↳ GRAM	↳ LOW	↳ END MODE	↳ LB	↳ 8 NONE	
	↳ KILOGRAM	↳ MED		↳ OFF	↳ STOP	
	↳ ZERO RANGE	↳ HI		↳ ON	↳ 1	
	↳ 0%	↳ AZT		↳ END UNIT	↳ 2	
	↳ 2%	↳ OFF			↳ HANDSHAKE	
	↳ 100%	↳ 0.5d			↳ NONE	
	↳ END SETUP	↳ 1d			↳ XON-XOFF	
		↳ 3d			↳ STABLE ONLY	
		↳ SLEEP			↳ OFF	
		↳ ON			↳ ON	
		↳ OFF			↳ AUTO PRINT	
		↳ LIGHT			↳ OFF	
		↳ HI			↳ ON STABLE	
		↳ MED			↳ LOAD	
		↳ LOW			↳ LOAD AND ZERO	
		↳ AUTO OFF			↳ INTERVAL	
		↳ OFF			↳ 1...3600	
		↳ SET 1			↳ CONTINUOUS	
		↳ SET 2			↳ CONTENT	
		↳ SET 5			↳ RESULT	
		↳ EXPAND MODE			↳ GROSS	
		↳ OFF			↳ NET	
		↳ ON			↳ TARE	
		↳ END READOUT			↳ UNIT	
					↳ MODE	
					↳ INFO	
					↳ LAYOUT	
					↳ FORMATE	
					↳ S	
					↳ M	
					↳ FEED	
					↳ LINE	
					↳ 4 LINES	
					↳ FORM	
					↳ END PRINT	

3.2 Menu Navigation

TO ENTER THE MENU MODE

Press and hold the Menu button until MENU appears on the display. The first upper level menu appears on the display.

Summary of button navigation functions in menu mode:

- Yes** Allows entry into the displayed menu.
 - Accepts the displayed setting and advances to the next menu item.
- No** Skips by the displayed menu.
 - Rejects the displayed setting or menu item and advances to the next available item.
- Back** Moves backwards through the upper and middle level menus.
 - Backs out of a list of selectable items to the previous middle level menu.
- Exit** Exits from menu directly to the active weighing mode.

3.3 Calibration Menu

Three calibration processes are available: Zero Calibration, Span Calibration and Linearity Calibration.

NOTES:

1. Make sure that appropriate calibration masses are available before beginning calibration.
2. Make sure that the scale base is level and stable during the entire calibration process.
3. Calibration is unavailable with LFT set to On.
4. Allow the Indicator to warm up for approximately 5 minutes after stabilizing to room temperature.
5. To abort calibration, press the **Exit** button anytime during the calibration process.
6. Make sure to finish Zero Calibration before performing Span Calibration to ensure weighing accuracy.

Zero	Perform
Span	Perform
Linearity	Perform
Geographic	
Adjustment	Set 00... Set 19 ... Set 31
End Calibration	Exit CALIBRATE menu

3.3.1 Zero Calibration

Zero Calibration uses one point. The calibration point is established with no load on the scale. Use this calibration method to adjust for a different pre-load without affecting the span or linearity calibration.

When [CAL] is displayed, press the YES key to accept the Calibration sub-menu selection. (Pressing the NO key to advance to the next sub-menu, [SETUP].)



When [ZER0] is displayed, press the YES key to accept the Zero Calibration menu item selection. The display flashes [0] and the kg led is light.



Press the Yes key to establish the zero point.



Note: The new zero point must be within the range of the normalized weight.

The display shows [--C--] while the zero point is established.

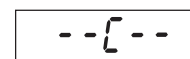

If zero calibration was successful, the scale exits to the next Calibration menu and displays [SPAN]



3.3.2 Span Calibration

Span Calibration uses one point. The span point is established with a calibration mass placed on the scale.



When SPAN is displayed, press the **Yes** button to access the Span Calibration menu item.

The display flashes the span calibration point. Place the specified weight on the scale and press the **Yes** button.



To choose a different span point, repeatedly press the **No** button to increment the selections or press the **Back** button to decrement the selections. Refer to Table 3-3 for available span points. When the desired value is displayed, place the specified weight on the scale and press the **Yes** button.



The display shows --C-- while the span point is established.

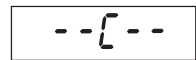

If span calibration was successful, the scale exits to the next Calibration menu and displays [LINEAr]



Note: Span Calibration should be performed after Zero Calibration.

3.3.3 Linearity Calibration

Linearity calibration uses 3 calibration points. The first calibration point is established with no weight on the scale. The second calibration point is established at approximately half capacity. The third calibration point is established at capacity. The Linearity calibration points are fixed and cannot be altered by the user during the calibration procedure. Refer to Table 3-3 for the linearity points.



When LINEAr is displayed, press the **Yes** button to access the Linearity Calibration menu item.

The display flashes 0. With no weight on the scale, press the **Yes** button to establish the zero point.



The display shows --C-- while the zero point is established.

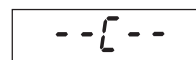

The display flashes the mid calibration point.

Place the specified weight on the scale and press the **Yes** button.



The display shows --C-- while the mid point is established.

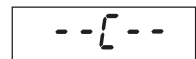

The display flashes the full calibration point.

Place the specified weight on the scale and press the **Yes** button.

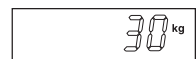

The display shows --C-- while the full point is established.

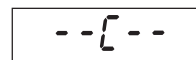

If linearity calibration was successful, the scale exits to the next Calibration menu and displays [GEO]



3.3.4 Geographical Adjustment Factor

The Geographical Adjustment Factor (GEO) is used to compensate for variations in gravity.

A rectangular digital display showing the text "GEO" in a monospaced font.

Attention: Changing the GEO Factor alters the calibration. The GEO value was set at the factory and should only be changed by an authorized manufacturer's representative or certified verification personnel.

A rectangular digital display showing the number "12" in a monospaced font.

Refer to table 3-2 to determine the GEO factor that corresponds to your location.

3.3.5 End Calibration

Advance to the next menu.

A rectangular digital display showing the text "End" in a monospaced font.

TABLE 3-2. GEOGRAPHICAL ADJUSTMENT VALUES

Geographical latitude away from the equator, (North or South) in degrees and minutes.		Elevation in meters										
		0	325	650	975	1300	1625	1950	2275	2600	2925	3250
		325	650	975	1300	1625	1950	2275	2600	2925	3250	3575
		Elevation in feet										
		0	1060	2130	3200	4260	5330	6400	7460	8530	9600	10660
		1060	2130	3200	4260	5330	6400	7460	8530	9600	10660	11730
Latitude		GEO value										
0°00'	5°46'	5	4	4	3	3	2	2	1	1	0	0
5°46'	9°52'	5	5	4	4	3	3	2	2	1	1	0
9°52'	12°44'	6	5	5	4	4	3	3	2	2	1	1
12°44'	15°06'	6	6	5	5	4	4	3	3	2	2	1
15°06'	17°10'	7	6	6	5	5	4	4	3	3	2	2
17°10'	19°02'	7	7	6	6	5	5	4	4	3	3	2
19°02'	20°45'	8	7	7	6	6	5	5	4	4	3	3
20°45'	22°22'	8	8	7	7	6	6	5	5	4	4	3
22°22'	23°54'	9	8	8	7	7	6	6	5	5	4	4
23°54'	25°21'	9	9	8	8	7	7	6	6	5	5	4
25°21'	26°45'	10	9	9	8	8	7	7	6	6	5	5
26°45'	28°06'	10	10	9	9	8	8	7	7	6	6	5
28°06'	29°25'	11	10	10	9	9	8	8	7	7	6	6
29°25'	30°41'	11	11	10	10	9	9	8	8	7	7	7
30°41'	31°56'	12	11	11	10	10	9	9	8	8	7	7
31°56'	33°09'	12	12	11	11	10	10	9	9	8	8	7
33°09'	34°21'	13	12	12	11	11	10	10	9	9	8	8
34°21'	35°31'	13	13	12	12	11	11	10	10	9	9	8
35°31'	36°41'	14	13	13	12	12	11	11	10	10	9	9
36°41'	37°50'	14	14	13	13	12	12	11	11	10	10	9
37°50'	38°58'	15	14	14	13	13	12	12	11	11	10	10
38°58'	40°05'	15	15	14	14	13	13	12	12	11	11	10
40°05'	41°12'	16	15	15	14	14	13	13	12	12	11	11
41°12'	42°19'	16	16	15	15	14	14	13	13	12	12	11
42°19'	43°26'	17	16	16	15	15	14	14	13	13	12	12
43°26'	44°32'	17	17	16	16	15	15	14	14	13	13	12
44°32'	45°38'	18	17	17	16	16	15	15	14	14	13	13
45°38'	46°45'	18	18	17	17	16	16	15	15	14	14	13
46°45'	47°51'	19	18	18	17	17	16	16	15	15	14	14
47°51'	48°58'	19	19	18	18	17	17	16	16	15	15	14
48°58'	50°06'	20	19	19	18	18	17	17	16	16	15	15
50°06'	51°13'	20	20	19	19	18	18	17	17	16	16	15
51°13'	52°22'	21	20	20	19	19	18	18	17	17	16	16
52°22'	53°31'	21	21	20	20	19	19	18	18	17	17	16
53°31'	54°41'	22	21	21	20	20	19	19	18	18	17	17
54°41'	55°52'	22	22	21	21	20	20	19	19	18	18	17
55°52'	57°04'	23	22	22	21	21	20	20	19	19	18	18
57°04'	58°17'	23	23	22	22	21	21	20	20	19	19	18
58°17'	59°32'	24	23	23	22	22	21	21	20	20	19	19
59°32'	60°49'	24	24	23	23	22	22	21	21	20	20	19
60°49'	62°09'	25	24	24	23	23	22	22	21	21	20	20
62°09'	63°30'	25	25	24	24	23	23	22	22	21	21	20
63°30'	64°55'	26	25	25	24	24	23	23	22	22	21	21
64°55'	66°24'	26	26	25	25	24	24	23	23	22	22	21
66°24'	67°57'	27	26	26	25	25	24	24	23	23	22	22
67°57'	69°35'	27	27	26	26	25	25	24	24	23	23	22
69°35'	71°21'	28	27	27	26	26	25	25	24	24	23	23
71°21'	73°16'	28	28	27	27	26	26	25	25	24	24	23
73°16'	75°24'	29	28	28	27	27	26	26	25	25	24	24
75°24'	77°52'	29	29	28	28	27	27	26	26	25	25	24
77°52'	80°56'	30	29	29	28	28	27	27	26	26	25	25
80°56'	85°45'	30	30	29	29	28	28	27	27	26	26	25
85°45'	90°00'	31	30	30	29	29	28	28	27	27	26	26

3.4 Setup Menu

SETUP

When the Indicator is used for the first time, enter this menu to set the Capacity and Graduation.

Reset	No , Yes
Capacity	5 ...20000 kg
Graduation	0.0005 ...20 kg
Power On Unit	Auto , kg, g, lb
Zero Range	2% , 100%
End Setup	Exit SETUP menu

3.4.1 Reset

Reset the Setup menu to the factory defaults.

- No = not reset.
- Yes = reset.

rESEt

no

YES

NOTE: If the Legal for Trade switch is switched to ON position, the Capacity, Graduation, Zero Range and settings are not reset.

3.4.2 Capacity

Set the scale capacity from 5 to 20000. Refer to the Setup Table 3.3 for available settings.

CAP

5kg

10kg

TABLE 3-3. SETUP AND CALIBRATION VALUES

Full Capacity		Graduation size(KG 1000~20000d)	Span calibration points
KG	LB		
5	10	0.0005,0.001,0.002,0.005	5
10	20	0.0005,0.001,0.002,0.005,0.01	5,10
15	30	0.001,0.002,0.005,0.01	5,10,15
20	40	0.001,0.002,0.005,0.01,0.02	5,10,15,20
25	50	0.002,0.005,0.01,0.02	5,10,15,20,25
30	60	0.002,0.005,0.01,0.02	5,10,15,20,25,30
40	80	0.002,0.005,0.01,0.02	5,10,15,20,25,30,40
50	100	0.005,0.01,0.02,0.05	5,10,15,20,25,30,40,50
60	150	0.005,0.01,0.02,0.05	5,10,15,20,25,30,40,50,60
75	160	0.005,0.01,0.02,0.05	5,10,15,20,25,30,40,50,60,75
100	200	0.005,0.01,0.02,0.05,0.1	5,10,15,20,25,30,40,50,60,75,100
120	250	0.01,0.02,0.05,0.1	5,10,15,20,25,30,40,50,60,75,100,120
150	300	0.01, 0.02,0.05,0.1	5,10,15,20,25,30,40,50,60,75,100,120,150
200	400	0.01,0.02,0.05,0.1,0.2	5,10,15,20,25,30,40,50,60,75,100,120,150,200
250	500	0.02,0.05,0.1,0.2	5,10,15,20,25,30,40,50,60,75,100,120,150,200,250
300	600	0.02,0.05,0.1,0.2	5,10,15,20,25,30,40,50,60,75,100,120,150,200,250,300
400	800	0.02,0.05,0.1,0.2	5,10,15,20,25,30,40,50,60,75,100,120,150,200,250,300,400
500	1000	0.5,0.1,0.2,0.5	5,10,15,20,25,30,40,50,60,75,100,120,150,200,250,300,400,500
600	1500	0.05,0.1,0.2,0.5	5,10,15,20,25,30,40,50,60,75,100,120,150,200,250,300,400,500,600
750	1600	0.05,0.1,0.2,0.5	5,10,15,20,25,30,40,50,60,75,100,120,150,200,250,300,400,500,600,750
1000	2000	0.05,0.1,0.2,0.5,1	5,10,15,20,25,30,40,50,60,75,100,120,150,200,250,300,400,500,600,750,1000
1200	2500	0.1,0.2,0.5,1	5,10,15,20,25,30,40,50,60,75,100,120,150,200,250,300,400,500,600,750,1000,1200
1500	3000	0.1,0.2,0.5,1	5,10,15,20,25,30,40,50,60,75,100,120,150,200,250,300,400,500,600,750,1000,1200,1500
2000	4000	0.1,0.2,0.5,1,2	5,10,15,20,25,30,40,50,60,75,100,120,150,200,250,300,400,500,600,750,1000,1200,1500,2000
2500	5000	0.2,0.5,1,2	5,10,15,20,25,30,40,50,60,75,100,120,150,200,250,300,400,500,600,750,1000,1200,1500,2000,2500
3000	6000	0.2,0.5,1,2	5,10,15,20,25,30,40,50,60,75,100,120,150,200,250,300,400,500,600,750,1000,1200,1500,2000,2500,3000
5000	10000	0.5,1,2,5	5,10,15,20,25,30,40,50,60,75,100,120,150,200,250,300,400,500,600,750,1000,1200,1500,2000,2500,3000,5000
6000	15000	0.5, 1,2,5	5,10,15,20,25,30,40,50,60,75,100,120,150,200,250,300,400,500,600,750,1000,1200,1500,2000,2500,3000,5000,6000
7500	16000	0.5,1,2,5	5,10,15,20,25,30,40,50,60,75,100,120,150,200,250,300,400,500,600,750,1000,1200,1500,2000,2500,3000,5000,7500
10000	20000	0.5,1,2,5,10	5,10,15,20,25,30,40,50,60,75,100,120,150,200,250,300,400,500,600,750,1000,1200,1500,2000,2500,3000,5000,7500,10000
12000	25000	1,2,5,10,20	5,10,15,20,25,30,40,50,60,75,100,120,150,200,250,300,400,500,600,750,1000,1200,1500,2000,2500,3000,4000,5000,6000,7500,10000,12000
15000	30000	1,2,5,10,20	5,10,15,20,25,30,40,50,60,75,100,120,150,200,250,300,400,500,600,750,1000,1200,1500,2000,2500,3000,4000,5000,6000,7500,10000,12000,15000
20000	40000	1,2,5,10,20	5,10,15,20,25,30,40,50,60,75,100,120,150,200,250,300,400,500,600,750,1000,1200,1500,2000,2500,3000,5000,7500,10000,20000

3.4.3 Graduation

Set the scale readability.

0.0005, 0.002, 0.005, 0.01, 0.02, 0.05, 0.1, 0.2, 0.5, 1, 2, 5, 10, 20.

NOTE: Not all settings are available for each capacity. Refer to the Setup Table 3-3 for available settings.

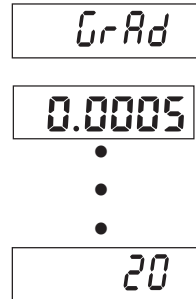

3.4.4 Power On Unit

Set the unit that will be active at power on.

Auto (last unit in use when power was turned off.), kg, g, lb



3.4.5 Zero Range

Set the percentage of scale capacity that may be zeroed.

2% = zero up to 2 percent of capacity

100% = zero up to full capacity

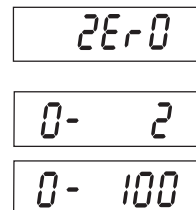

3.4.6 End Setup

Advance to the next menu.

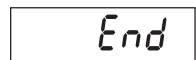

3.5 Readout Menu

Enter this menu to customize display functionality.

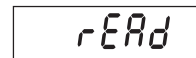

Reset:	No , Yes
Stable Range:	0.5d, 1d , 2d, 5d
Filter:	Lo, Med , Hi
Auto Zero Tracking	Off, 0.5d , 1d, 3d
Sleep:	Off , On
Light:	HI , Med, Low
Auto Off:	Off , 1, 5, 10 (min)
Expand:	Off , On
End Readout	Exit READOUT menu

3.5.1 Reset

Set the Readout menu to factory default settings.

No = not reset

Yes = reset

If the Legal for Trade menu item is set to ON, the Stable Range, Averaging Level, Auto Zero Tracking and Auto Off settings are not reset.

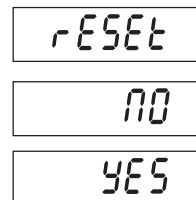

3.5.2 Stable Range

Set the stable range.

- 0.5d
- 1d
- 2d
- 5d

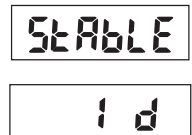

3.5.3 Filter

Set the amount of signal filtering.

- LO = less stability, faster stabilization time (≤ 1 sec.)
- MEd = normal stability, stabilization time (≤ 2 sec.)
- HI = greater stability, slower stabilization time (≤ 3 sec.)



3.5.4 Auto-Zero Tracking

Set the automatic zero tracking functionality.

- OFF = disabled.
- 0.5 d = the display will maintain zero until a drift of 0.5 divisions per second has been exceeded.
- 1 d = the display will maintain zero until a drift of 1 division per second has been exceeded.
- 3 d = the display will maintain zero until a drift of 3 divisions per second has been exceeded.

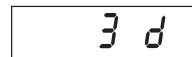
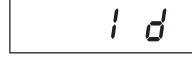
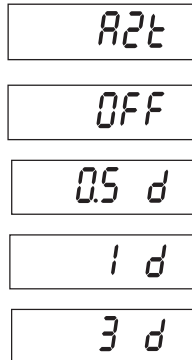

NOTE: When the LFT menu item is set to ON, the selections are limited to 0.5d and 3d. The setting is locked when the hardware lock switch is set to the ON position.

3.5.5 Sleep

Set the terminal sleep functionality.

- OFF = Terminal will not sleep.
- ON = Terminal will sleep.



3.5.6 Light

Set the backlight brightness.

- HI = High brightness.
- MED = Medium brightness.
- LOW = Low brightness.

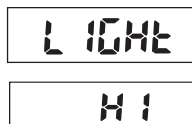

3.5.7 Auto Off

Set the automatic shut off functionality.

- OFF = disabled
- 1 = powers off after 1 minute of no activity.
- 5 = powers off after 5 minutes of no activity.
- 10 = powers off after 10 minutes of no activity.

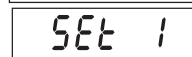
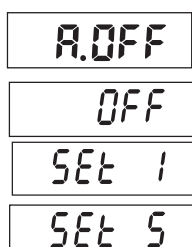

3.5.8 Expand

Set the expand functionality.

- OFF = disabled
- ON = Expands



3.5.9 End Readout

Advance to the next menu.

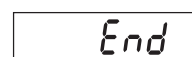

3.6 Mode Menu

Enter this menu to activate the desired application modes.

MODE

Reset:	No , Yes
Count:	Off , On
Totalize:	Off , On
End Mode	Exit MODE menu

3.6.1 Reset

Set the Mode menu to the factory defaults.

- No = not reset.
- Yes = reset.

RESET

NO

YES

3.6.2 Parts Counting Mode

Set the status.

- OFF = Disabled
- ON = Enabled

COUNT

OFF

ON

3.6.3 Totalize Mode

Set the status.

- OFF = Disabled
- ON = Enabled

TOTAL

OFF

End

3.6.4 End Mode

Advance to the next menu.

3.7 Unit Menu

Enter this menu to activate the desired units.

Default settings are bold.

UNIT

Reset:	No , Yes
Kilograms:	Off, On
Grams:	Off, On
Pounds:	Off , On
End Unit	Exit UNIT menu

3.7.1 Reset

Set the Unit menu to the factory defaults.

- NO = not reset.
- YES = reset

RESET

NO

YES

3.7.2 Kilogram Unit

Set the status.

- OFF = Disabled
- ON = Enabled

UNIT_{kg}

OFF

ON

3.7.3 Gram Unit

Set the status.

- OFF = Disabled
- ON = Enabled

UNIT_g

OFF

ON

3.7.3 Pound Unit

Set the status.

- OFF = Disabled
- ON = Enabled

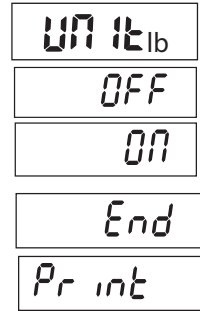

3.7.4 End Unit

Advance to the next menu.

3.8 Print Menu (appears only with RS232 option installed)

Enter this menu to define printing parameters. Default settings are bold.

3.8.1 Reset

Set the Print menu to factory defaults.

- NO = not reset.
- YES = reset.

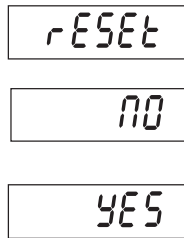

Reset	No , Yes
Baud Rate:	300, 600, 1200, 2400, 4800, 9600 , 19200
Parity:	7 Even, 7 Odd, 7 None, 8 None
Stop Bit	1 or 2
Handshake:	Off , XON/XOFF
Stable Only	Off , On
Auto Print	Off , On Stable (-> Load, Load and Zero), Interval (-> 1...3600), Continuous
Content	Result (->Off, On , NUM) Gross (-> Off , On) Net (-> Off , On) Tare (-> Off , On) Unit (-> Off , On) Mode (-> Off , On) Info (-> Off , On)
Layout	Format (->Multiple, Single) Feed (->Line Feed, 4 Line Feed, Form Feed)
End Print	Exit PRINT menu

NOTE: If the Legal for Trade menu item is set to ON, the following settings are not reset: Stable, Auto Print

3.8.2 Baud

Set the Baud rate.

- 300 = 300 bps
- 600 = 600 bps
- 1200 = 1200 bps
- 2400 = 2400 bps
- 4800 = 4800 bps
- 9600 = 9600 bps
- 19200 = 19200 bps

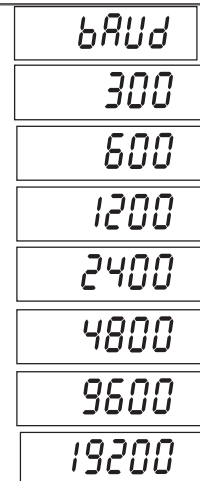

3.8.3 Parity

Set the data bits and parity.

- 7 EVEN = 7 data bits, even parity.
- 7 Odd = 7 data bits, odd parity.
- 7 NONE = 7 data bits, no parity.
- 8 NONE = 8 data bits, no parity.

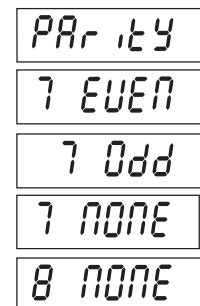

3.8.4 Stop Bit

Set the number of stop bits.

- 1 = 1 stop bit.
- 2 = 2 stop bits.

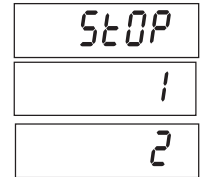

3.8.5 Handshake

Set the flow control method.

- NONE = no handshaking.
- ON-OFF = XON/XOFF software handshaking.



3.8.6 Stable Only

Set the print criteria.

- OFF = values are printed immediately.
- ON = values are only printed when the stability criteria are met.

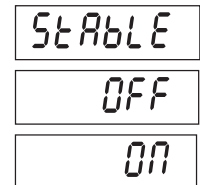

3.8.7 Auto Print

Set the automatic printing functionality.

- OFF = disabled.
- ON.StAb = printing occurs each time the stability criteria are met.
- INtEr = printing occurs at the defined interval.
- CONt = printing occurs continuously.



When INtEr is selected, set the Print Interval.
1 to 3600 (seconds)

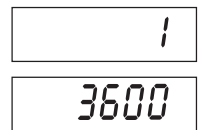

3.8.8 Content

Select the additional content of the printout.

- RESULT OFF = Result is not printed.
- ON = Result weight is printed.
- NUM = Numeric portion of the displayed reading is printed.
- GROSS OFF = Gross weight is not printed.
- ON = Gross weight is printed.
- NET OFF = Net weight is not printed.
- ON = Net weight is printed.
- TARE OFF = Tare weight is not printed.
- ON = Tare weight is printed.
- UNIT OFF = Unit is not printed.
- ON = Unit weight is printed.
- MODE OFF = Mode is not printed.
- ON = Mode is printed.
- INFO OFF = Info is not printed.
- ON = Info is printed.

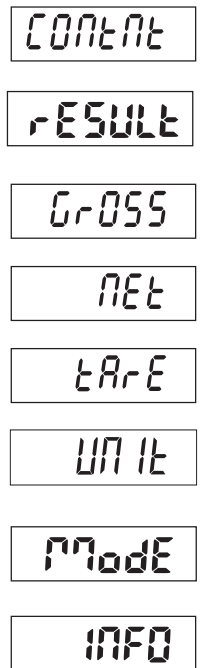

3.8.9 Layout

Set the layout criteria.

FORMAT

Multi = multiple lines are printed.

Single = single line is printed.

FEED

Line = move paper up one line after printing.

4 Lines = move paper up four lines after printing

Form = move paper to top of next page (form feed) after printing.

LAYOUT

FORMAT

MULTI

SINGLE

FEED

LINE

4.LINE

FORM

3.8.10 End Print

Advance to the next menu.

End

3.9 Security Switch

A security switch is located on the Main PCB board. When the switch is set to the on position, user menu settings that were locked in the Menu Lock can not be changed.

Open the housing as explained in Section 2.3.1. Set the position of security switch, seen in Figure 1-2, to ON.

4 OPERATION

4.1 Turning Indicator On/Off

To turn the Indicator on, press the and hold the **ON/ZERO Off** button for 2 seconds. The Indicator performs a display test, momentarily displays the software version, and then enters the active weighing mode.

To turn the Indicator off, press and hold the **ON/ZERO Off** button until OFF is displayed.

4.2 Zero Operation

Zero can be set under the following conditions:

- Automatically at Power On (initial zero).
- Semi-automatically (manually) by pressing the **ON/ZERO Off** button.
- Semi-automatically by sending the Zero command (Z or alternate zero command).

Press the **ON/ZERO Off** button to zero the weight display. The scale must be stable to accept zero operation.

4.3 Manual Tare

When weighing an item that must be held in a container, taring stores the container weight in memory. Place the empty container on the scale (example 0.5 kg) and press the **TARE** button. The display will show the net weight.

To clear the Tare value, empty the scale and press the **TARE** button. The display will show the gross weight.

4.4 Changing Units of Measure

Press and hold the **PRINT Units** button until the desired measuring unit appears. Only measuring units enabled in the Unit Menu will be displayed (refer to Section 3.7).

4.5 Printing Data

Printing the displayed data to a printer or sending the data to a computer requires that the communication parameters in the Print Menu are set (refer to Section 3.8).

Press the **PRINT Units** button to send the displayed data to the communication port (the Auto-Print Mode in Section 3.8 function must be Off).

4.6 Application Modes

Only modes enabled in the mode menu will be displayed (refer to Section 3-6).

4.6.1 Weighing

Place the item to be weighed on the scale. The illustration indicates a sample of 1.5 kg, Gross weight.



Note: To return to the Weighing mode from the Parts Counting mode, press and hold the **Mode** button until WEIGH is displayed.



4.6.2 Parts Counting

Use this mode to count parts of uniform weight. The Indicator determines the quantity based on the average weight of a single part. All parts must be uniform in weight for accurate measurements.



To enter the Parts Counting mode, press and hold the **Mode** button until Count is displayed.

Average Piece Weight (APW)

When the **Mode** button is released, CLr.PW Pcs is displayed.



NOTE: If no APW has been previously stored, the CLr.PW display is skipped and the display shows PU10Pcs.

Clearing a Stored APW

Press the **Yes** button to clear the stored APW.

Recalling a Stored APW

Press the **No** button to recall the existing APW.
 Press the **FUNCTION Mode** button to temporarily display the APW value.

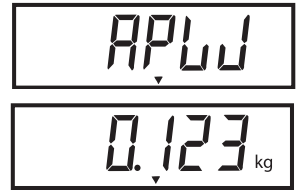

Establishing the Average Piece Weight (APW)

The display shows Put10 Pcs.



Establishing a New APW

Press the **No** button to increment the sample size. Choices are 5, 10, 20, 50, 100 and 200.

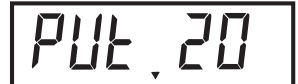

To establish the APW, place the specified quantity of samples on the scale and press the **Yes** button to capture the weight.



Begin Counting

Place the parts on the scale and read the count. If a container is used, be sure to tare the empty container first.



4.6.3 Totalization

Totalization measures the cumulative weight of a sequence of items.
 To enter the Totalization mode, press and hold the **Mode** button until Total is displayed.
 After selecting Totalization mode, [clr.Acc] is shown on the display.
 Pressing the YES key clears the Accumulating data.
 Pressing the NO key advances to the Totalization mode and future accumulation will be based on the stored accumulating data, and [0] is displayed.
 Note: If Print is "on" the zero is not printed.



Pressing the Function/Mode key either starts Totalization or adds the new displayed value to the accumulated total and displays the new total value. The Accum indicator will blink when the value is shown.

Display accumulated data:

To display the accumulated data, with no weight on pan press Function/Mode key once.

Pressing the ZERO key zeros the display if required (without affecting the stored total value).

Exit / Clear Totalization

Long press the Function/Mode key to scroll through the modes.

5 SERIAL COMMUNICATION

The Indicators include an RS232 serial communication interface. An optional RS232 serial communication interface can also be installed if required.

Note: Some indicators does not include an RS232 serial communication interface. An optional RS232 serial communication interface (PN:30101019) needs to be purchased.

The setup of RS232 operating parameters are more fully explained in Section 3.8. The physical hardware connection is explained in in Section 2.2.

5.1 Interface Commands

The interface enables display data to be sent to a computer or printer. A computer can be used to control some functions of the indicator using the commands listed in Table 5-1.

Command Character	Legacy Command (2)	Function
IP		Immediate Print of displayed weight (stable or unstable).
P		Print stable displayed weight (according to stability setting).
CP	CA	Continuous Print.
SP		Print when stable.
xS		OS: Turn off "Stable Only" menu item and allow unstable print. 1S: Turn on "Stable Only" menu item and only print stable print.
xP	xA	Interval Print x = Print Interval (1-3600 sec), OP turns auto print OFF
Z		Same as pressing Zero button
T		Same as pressing Tare button
xT		Download Tare value in grams (positive values only). Sending OT clears tare (if allowed)
PU		Print current unit: g, kg, lb, PCS
xU		Set scale to unit x: 1=g, 2=kg, 3=lb
xM		Set scale to mode x. M will scroll to next available mode.
PV	V	Version: print name, software revision and LFT ON (if LFT is set ON).
Esc R		Global reset to reset all menu settings to the original factory defaults

NOTES:

- Commands sent to the Indicator must be terminated with a carriage return-line feed (CRLF).
- Data output by the Indicator is always terminated with a carriage return-line feed (CRLF).
- The Legacy Commands maintain compatibility with older products

5.2 Output Format

The default serial output format is shown below.

Field:	Weight	Space	Unit	Space	Stability	Space	G/N/T	Term. Char(s)
Length:	11	1	5	1	1	1	1	

Definitions:

Weight, up to 11 characters, right justified, '-' at immediate left of most significant character (if negative).

Unit, up to 5 characters, right justified. If the Unit in the Print Content menu was set to OFF, the unit will be removed in the weight string, and 5 spaces will be printed.

Stability, "?" character is printed if not stable, 1 space if stable.

G/N/T: "N" printed if weight is net weight, 'G' or space printed if weight is a gross weight.

Terminating Character(s) – terminating character(s) printed depending on FEED menu setting.

5.3 Printout Examples

Weigh Mode

Maximum 24 characters

```

12.34 KG N
12.34 KG G
11.11 KG N
 1.22 KG T
MODE: WEIGH
    
```

Description	Comment
PCS Result line	`N'printed if a tare value is enteredesult line
Gross value line	If Print -> Content -> Gross is ON and a tare value is entered
Net value line	If Print -> Content -> Net is ON and a tare value is entered
Tare value line	If Print -> Content -> Tare is ON and a tare value is entered
Information line	If Count Mode is ON, left justified

Count Mode

Maximum 24 characters

```

810 PCS N
12.34 KG G
 9.72 KG N
 2.62 KG T
APW: 0.012 KG
    
```

Description	Comment
PCS Result line	`N'printed if a tare value is enteredesult line
Gross value line	If Print -> Content -> Gross is ON and a tare value is entered
Net value line	If Print -> Content -> Net is ON and a tare value is entered
Tare value line	If Print -> Content -> Tare is ON and a tare value is entered
Information line	If Count Mode is ON, left justified

Totalization Mode

Maximum 24 characters

```

810 PCS N
12.34 KG G
 9.72 KG N
 2.62 KG T
N: 3
23.45KG TOTAL
Mode: TOTAL
    
```

Description	Comment
PCS Result line	`N'printed if a tare value is enteredesult line
Gross value line	If Print -> Content -> Gross is ON and a tare value is entered
Net value line	If Print -> Content -> Net is ON and a tare value is entered
Tare value line	If Print -> Content -> Tare is ON and a tare value is entered
Information line	If Count Mode is ON, left justified
Mode line	If Totalization Mode is ON, left justified

6. LEGAL FOR TRADE

6.1 Settings

Enter the menu and perform a calibration as explained in Section 3 and then exit the Setup menu and power off the indicator.

Open the housing as explained in Section 2.3.1.

Set the position of the security switch, shown in Figure 1-2, to ON (item 4).

Close the housing.

NOTE: When the security switch is set to ON, the following menu settings cannot be changed:

Span Calibration, Linearity Calibration, Calibration Unit, GEO, Capacity, Graduation, Zero Range, Stable Range, AZT, Modes, Units. To enable editing of these menu settings, return the security switch to the off position.

6.2 Verification

Before this product can be used in a trade approved application, it must be inspected in accordance with local weights and measures regulations. It is the responsibility of the purchaser to ensure that all pertinent legal requirements are met. Please contact your local weights and measures office for further details.

7 MAINTENANCE



CAUTION: DISCONNECT THE UNIT FROM THE POWER SUPPLY BEFORE CLEANING.

7.1 Cleaning

- The housing may be cleaned with a cloth dampened with a mild detergent if necessary.
- Do not use solvents, chemicals, alcohol, ammonia or abrasives to clean the housing or control panel.

7.2 Troubleshooting

TABLE 7-1. TROUBLESHOOTING.

Error Code	Description	Cause
Error 8.1	Power On Error	Weight reading exceeds Power On Zero limit.
Error 8.2	Power On Error	Weight reading below Power On Zero limit.
Error 8.3	Over Range Error	Weight reading exceeds Overload limit.
Error 8.4	Under Range Error	Weight reading below Underload limit.
Error 8.5	Tare out of range Error	Tared at one unit but after switching to another unit the tare value exceed the max.
Error 8.6	Display Overflow	Weight exceeds 6 digits. Happened in the cases of Accumulation or counting PCS display
-----	Busy message	Displayed during tare setting, zero setting, printing
--NO--	Action not allowed message	Function not executed.
Battery icon flashing	Low Battery error	Battery is empty
CAL E	Calibration Error	Calibration value outside allowable limits
Lo.rEF	Low reference weight warning message	Average Piece Weight too small. (Warning)
rEF.Err	Unacceptable reference weight message	Reference Weight too small. The weight on the pan is too small to define a valid reference weight.

7.3 Service Information

If the troubleshooting section does not resolve your problem, contact an authorized Ohaus Service Agent. For Service assistance in the United States, call toll-free 1-800-526-0659 between 8:00 AM and 5:00 PM Eastern Standard Time. An Ohaus Product Service Specialist will be available to assist you. Outside the USA, please visit our website www.ohaus.com to locate the Ohaus office nearest you.

8. TECHNICAL DATA

8.1 Specifications

Materials

Housing: ABS plastic

Keypad: polyester

Display Window: Polycarbonate

Ambient conditions

The technical data is valid under the following ambient conditions:

Indoor use only

Ambient temperature: -10°C to 40°C / 14°F to 104°F

Relative humidity: Maximum relative humidity 80% for temperatures up to 31°C decreasing linearly to 50% relative humidity at 40°C.

Altitude: up to 2000m

Mains supply voltage fluctuations: up to ±10% of the nominal voltage

Installation category: II

Pollution degree: 2

Protection class: III

TABLE 8-1. SPECIFICATIONS

Indicator	TD32PE
Capacity	up to 20,000 kg
Maximum Displayed Resolution	1:20,000
Weighing Units	kg, g, lb
Functions	Weighing, Parts Counting, Accumulation
Construction	ABS plastic housing
Display	6-digit, 7-segment red LED, 20 mm high digits
Keyboard	4-function mechanical keys, raised, tactile
Load Cell Excitation Voltage	3V DC
Load Cell Drive	Up to 4 x 350 ohm Load Cells
Load Cell Input Sensitivity	Up to 3 mV/V
Stabilization Time	1 Second
Auto-zero Tracking	Off, 0.5, 1 or 3 Divisions
Zero Range	2% or 100% of full scale capacity
Power	12V, 1A AC adapter with internal rechargeable lead acid battery, 80 hours continuous use with 12 hour recharge time
Interface	Optional RS232
Operating Temperature Range	-10°C to 40°C/14°F to 104°F
Housing Dimensions (W x D x H)	210 x 168 x 80 mm / 8.27 x 6.61 x 3.15 in
Net Weight	1.4 kg / 3.1 lb
Shipping Weight	2.4 kg / 5.3 lb
Shipping Dimensions (W x D x H)	272 x 235 x 175 mm / 10.71 x 9.25 x 6.89 in

8.2 Accessories**TABLE 8-2. ACCESSORIES.**

DESCRIPTION	PART NUMBER
In_use_cover, T31P, T24P	30101017
Column adapter Kit, D2K	30101020
Cable Kit, Load Cell, D2K	30101021
Printer, Impact, SF40A	30045641

8.3 Drawings and Dimensions

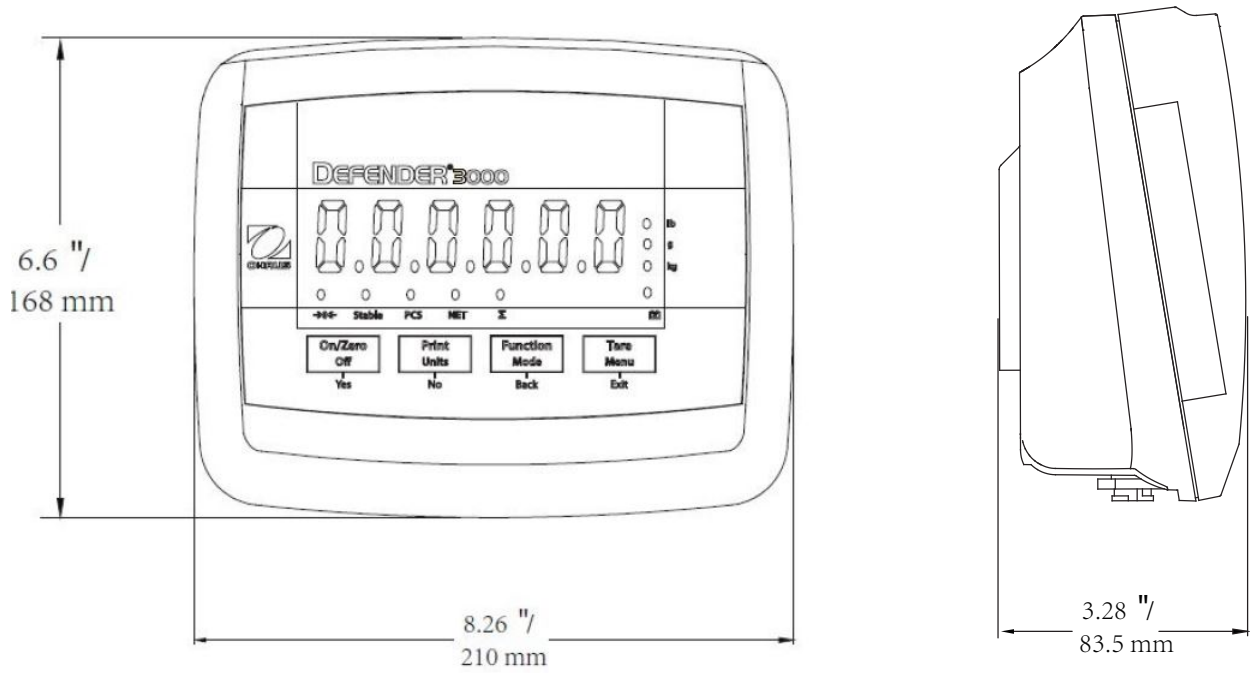



Figure 8-1. Indicator Overall Dimensions.

8.4 Compliance

Compliance to the following standards is indicated by the corresponding marking on the product.

Marking	Standard
	This product conforms to the EMC Directive 2004/108/EC and the Low Voltage Directive 2006/95/EC. The complete Declaration of Conformity is available online at www.ohaus.com/ce .



Disposal

In conformance with the European Directive 2002/96/EC on Waste Electrical and Electronic Equipment (WEEE) this device may not be disposed of in domestic waste. This also applies to countries outside the EU, per their specific requirements.

The Batteries Directive 2006/66/EC introduces new requirements from September 2008 on removability of batteries from waste equipment in EU Member States. To comply with this Directive, this device has been designed for safe removal of the batteries at end-of-life by a waste treatment facility. Please dispose of this product in accordance with local regulations at the collecting point specified for electrical and electronic equipment.

If you have any questions, please contact the responsible authority or the distributor from which you purchased this device.

For disposal instructions in Europe, refer to www.ohaus.com/weee.

Thank you for your contribution to environmental protection.

FCC Note

This equipment has been tested and found to comply with the limits for a Class B digital device, pursuant to Part 15 of the FCC Rules.

These limits are designed to provide reasonable protection against harmful interference in a residential installation. This equipment generates, uses and can radiate radio frequency energy and, if not installed and used in accordance with the instructions, may cause harmful interference to radio communications. However, there is no guarantee that interference will not occur in a particular installation. If this equipment does cause harmful interference to radio or television reception, which can be determined by turning the equipment off and on, the user is encouraged to try to correct the interference by one or more of the following measures:

- Reorient or relocate the receiving antenna.
- Increase the separation between the equipment and receiver.
- Connect the equipment into an outlet on a circuit different from that to which the receiver is connected.
- Consult the dealer or an experienced radio/TV technician for help.

Industry Canada Note

This Class B digital apparatus complies with the Canadian ICES-003.
 Cet appareil numérique de la classe B est conforme à la Norme NMB-003 du Canada.

ISO 9001 Registration

In 1994, Ohaus Corporation, USA, was awarded a certificate of registration to ISO 9001 by Bureau Veritas Quality International (BVQI), confirming that the Ohaus quality management system is compliant with the ISO 9001 standard's requirements. On May 21, 2009, Ohaus Corporation, USA, was re-registered to the ISO 9001:2008 standard.

LIMITED WARRANTY

Ohaus products are warranted against defects in materials and workmanship from the date of delivery through the duration of the warranty period. During the warranty period Ohaus will repair, or, at its option, replace any component(s) that proves to be defective at No charge, provided that the product is returned, freight prepaid, to Ohaus.

This warranty does Not apply if the product has been damaged by accident or misuse, exposed to radioactive or corrosive materials, has foreign material penetrating to the inside of the product, or as a result of service or modification by other than Ohaus. In lieu of a properly returned warranty registration card, the warranty period shall begin on the date of shipment to the authorized dealer. No other express or implied warranty is given by Ohaus Corporation. Ohaus Corporation shall Not be liable for any consequential damages.

As warranty legislation differs from state to state and country to country, please contact Ohaus or your local Ohaus dealer for further details.



Ohaus Corporation
7 Campus Drive
Suite 310
Parsippany, NJ 07054, USA
Tel: +1 (973) 377-9000
Fax: +1 (973) 944-7177
www.ohaus.com



P/N 30529806 A © 2019 Ohaus Corporation, all rights reserved.

Printed in China