

WTC

WTC 200 Precision Balance
WTC 600.1 Precision Balance
WTC 2000 Precision Balance
WTC 3000 Precision Balance

USER MANUAL

ITKU-95-03-11-16-EN



NOVEMBER 2016

CONTENTS

1. GENERAL INFORMATION	5
2. PRECAUTIONS	5
2.1. Maintenance	5
2.2. Battery	5
3. WARRANTY CONDITIONS.....	6
4. BALANCE DESIGN.....	6
4.1. Dimensions.....	6
4.2. Connection Cables - Diagrams	8
4.3. Connectors Description	8
5. UNPACKING AND INSTALLATION	8
6. START-UP	9
6.1. Levelling	9
6.2. Powering the Device	9
6.3. Battery Status	9
6.4. Battery Power	10
7. MAINTENANCE ACTIVITIES.....	10
7.1. Cleaning ABS Components	10
7.2. Cleaning Stainless Steel Components	10
8. TEMPERATURE STABILIZATION	11
9. KEYPAD	11
10. KEYS	11
11. PROGRAM	12
12. OPERATING BALANCE MENU	16
12.1. Keypad	16
12.2. Return to the Weighing Mode	17
13. WEIGHING	17
13.1. Taring.....	18
13.2. Manual Tare Entering	18
13.3. Zeroing.....	19
13.4. Weighing for Dual Range Balances.....	19
13.5. Units	20
13.5.1. Start Unit	20
13.5.2. Temporary Unit.....	20
14. BALANCE PARAMETERS	21
14.1. Filter Level	21
14.2. Value Release.....	21
14.3. Balance Ambient Conditions.....	22
14.4. Autozero.....	22
14.5. Tare	23
14.6. Last Digit	23
15. ADJUSTMENT	23
15.1. External Adjustment.....	24
15.2. User Adjustment	24
15.3. Adjustment Report	25
16. INTERFACES	25
16.1. RS232 Settings	25
16.1.1. Baud Rate	26
16.1.2. Parity	26
17. PERIPHERALS	26
17.1. Computer	26
17.1.1. Computer Port	26
17.1.2. Continuous Transmission.....	27
17.1.3. Interval For Printouts During Continuous Transmission.....	27
17.2. Printer	27
17.2.1. Printer Port	27
18. PRINTOUTS	28
18.1. Adjustment Report Printout.....	28
18.2. GLP Printout	29

19. MISCELLANEOUS	29
19.1. Backlight	30
19.2. 'Beep' Sound.....	30
19.3. Automatic Shutdown.....	30
19.4. Date	31
19.5. Time	31
19.6. Date Format.....	32
19.7. Time Format.....	32
19.8. User Menu Default Settings.....	32
20. INFORMATION	33
21. WORKING MODES	33
21.1. Running Working Mode.....	33
21.2. Working Modes Settings.....	33
21.3. Weighing.....	34
21.3.1. Working Mode Accessibility	34
21.3.2. Save Mode	34
21.3.3. LO Threshold.....	35
21.4. Parts Counting	35
21.4.1. Working Mode Accessibility	35
21.4.2. Selecting Working Mode	35
21.4.3. Save Mode	36
21.4.4. LO Threshold.....	36
21.4.5. Setting Reference Mass by Entering Mass of a Single Part.....	36
21.4.6. Setting Reference Mass by Determining Mass of a Single Part.....	36
21.5. +/- Control	37
21.5.1. Working Mode Accessibility	38
21.5.2. Save Mode	38
21.5.3. LO Threshold.....	38
21.5.4. Declaring Checkweighing Thresholds.....	38
21.6. Percent Weighing Against Reference Sample Mass.....	39
21.6.1. Working Mode Accessibility	39
21.6.2. Selecting Working Mode	39
21.6.3. Save Mode	40
21.6.4. LO Threshold.....	40
21.6.5. Reference Mass Determined by Weighing.....	40
21.6.6. Reference Mass Determined by Entering.....	40
21.7. Peak Hold	41
21.7.1. Working Mode Accessibility	41
21.7.2. LO Threshold.....	41
21.7.3. Means of Operation	41
21.8. Totalizing.....	42
21.8.1. Working Mode Accessibility	42
21.8.2. Save Mode	42
21.8.3. LO Threshold.....	42
21.8.4. Totalizing Procedure	42
22. DIAGRAMS OF CONNECTION CABLES	44
23. COMMUNICATION PROTOCOL	44
23.1. General Information	44
23.2. List of Commands.....	45
23.3. Response Format	45
23.4. Commands Overview.....	46
23.5. Manual Printout / Automatic Printout	52
23.6. Continuous Transmission	53
24. TECHNICAL SPECIFICATIONS	54
25. TROUBLESHOOTING	54
26. ERROR MESSAGES	55
27. ADDITIONAL EQUIPMENT	55

1. GENERAL INFORMATION

WTC precision balance enables fast and accurate mass measurements under laboratory conditions.

The weighing pan, made of stainless steel and equipped with anti-draft shield, is an integral part of WTC balance. Backlit LCD display ensures clear measurement result. WTC balance is equipped with an internal battery (comes standard), so it does not have to be connected to the mains.

WTC balance is equipped with the following interfaces: RS 232, USB type A, USB type B. The interfaces enable cooperation between the balance and peripheral devices (e.g. printer, computer, flash drive).

2. PRECAUTIONS

2.1. Maintenance

- A. Prior first use, carefully read this User Manual. Use the balance only as intended.
- B. Balance to be decommissioned, should be decommissioned in accordance with valid legal regulations.

2.2. Battery

WTC balance is supplied by **NiMH-type** battery (nickel-metal-hydrogen) of **1800-2800mAh** capacity.



In case of prolonged storage of the balance in low temperature, the battery has to be charged.



A worn out battery can be replaced only by the manufacturer or by the authorized service.



The equipment including accumulators does not belong to regular household waste. The European legislation requires electric and electronic equipment to be collected and disposed separately from other communal waste with the aim of being recycled.

Notice:

Symbols on accumulators identify harmful compounds: Pb = lead, Cd = cadmium, Hg = mercury.

3. WARRANTY CONDITIONS

- A. RADWAG feels obliged to repair or exchange all elements that appear to be faulty by production or by construction,
- B. Defining defects of unclear origin defects and means of their elimination can only be realized with assistance of manufacturer and user representatives,
- C. RADWAG does not bear any responsibility for defects or losses resulting from unauthorized or inadequate performing of production or service processes,
- D. Warranty does not cover:
 - mechanical defects caused by product exploitation other than intended, defects of thermal and chemical origin, defects caused by lightning, overvoltage in the power network or other random event,
 - Inappropriate cleaning.
- E. Loss of warranty takes place if:
 - a repair is carried out outside RADWAG authorized service point,
 - service claims intrusion into mechanical or electronic construction by unauthorized people,
 - the balance does not bear company protective stickers.
- F. Warranty conditions outline the warranty period for rechargeable batteries attached to the balance for 12 months.
- G. For detailed warranty conditions go to the warranty certificate.
- H. Contact with the central authorized service: (0-48) 384 88 00 ext. 106 and 107.

4. BALANCE DESIGN

4.1. Dimensions

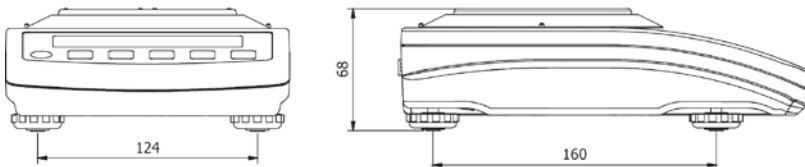

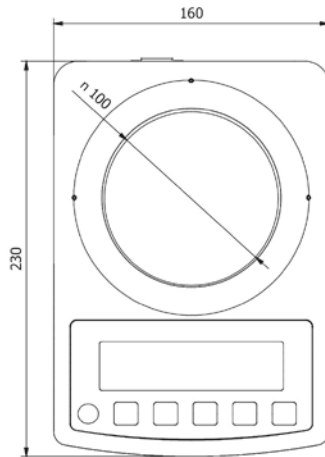

Fig.1. Dimensions of WTC 200 precision balance.

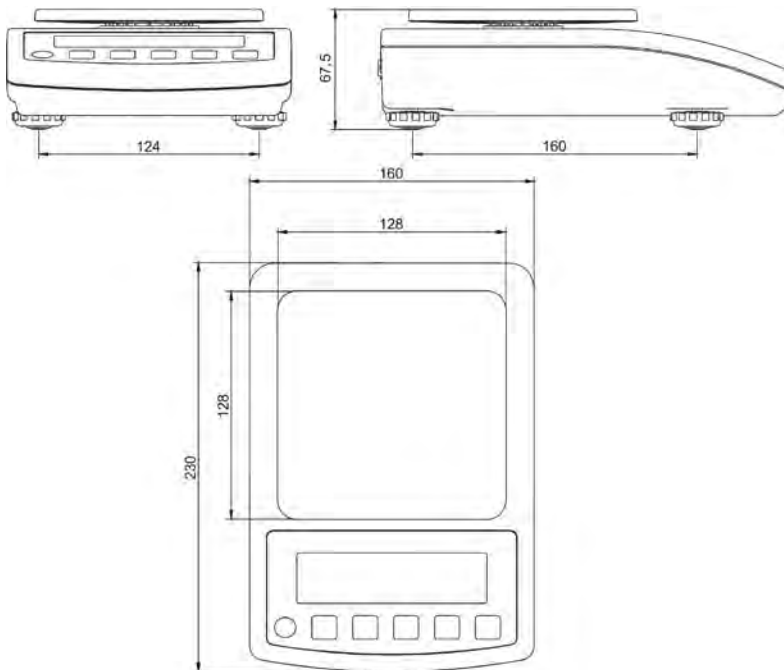

Fig.2. Dimensions of WTC 600.1, WTC 2000 and WTC 3000 precision balances.

4.2. Connection Cables - Diagrams

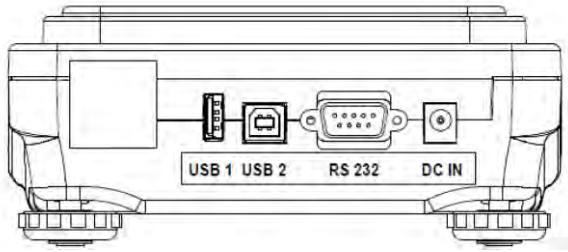

Fig. 3. Interfaces view

- DC IN - power outlet
- RS232 - RS 232 connector
- USB 2 - USB 'device' connector
- USB 1 - USB 'host' connector

4.3. Connectors Description

<p>The diagram shows a male DB9 connector with nine pins. Pin 2 is labeled 'RxD', pin 3 is labeled 'TxD', and pin 5 is labeled 'GND'. There are also labels 'E1' and 'E2' on the left side of the connector.</p>	<p>Pin2 – RxD Pin3 – TxD Pin5 – GND</p>	<p>RS 232 DB9/M connector (male)</p>
--	---	---

5. UNPACKING AND INSTALLATION

- A. Take the device out of the packaging.
- B. Place the balance on a flat and even surface. Keep it far away from any sources of heat.
- C. Install the weighing pan and anti-draft shields in accordance with fig.4.

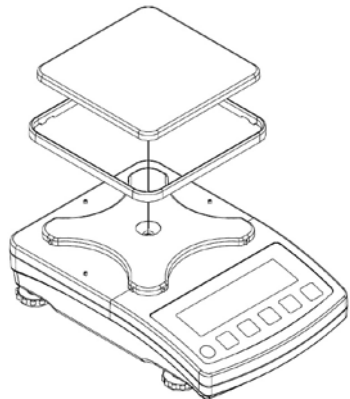
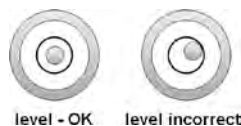

Fig. 4. Balance installation

6. START-UP

6.1. Levelling

- Prior first use level the balance. To level a balance turn its feet, keep turning the feet until the air bubble takes central position.



6.2. Powering the Device

Caution:

Balance can be connected to the mains only with a power adapter that comes standard with the particular model. Nominal power supply of the power adapter (specified on the power adapter data plate) has to be compatible to the power from the mains.

Plug the balance to the mains – connect the power adapter to the socket, next connect its connector to interface located at the back of the balance housing.



Turn the balance on or off using key.

Test of the display unit takes place right after connecting the balance to the power, all the elements and pictograms are backlit for a short time. Next, the name and the program number appear, the indication gets to ZERO (displayed reading unit depends on the balance).



If the indication is different than zero, press button.



6.3. Battery Status

An internal battery comes standard with the balance.  pictogram, displayed at the top of the display, signals battery status.

Pictogram operation	Overview
No pictogram	Battery full. Standard balance operation.
Pictogram displayed continuously	Battery status low. The balance will shut down. Immediately charge the battery.
Pictogram blinks every 1 s.	Battery charging. Balance connected to power supplier, the battery is being charged.
Pictogram blinks every 0.5 s.	Battery error. Battery damaged.

6.4. Battery Power



- Simultaneously press  and  keys.
- Battery power given in % is displayed for 2s.
- Wait for the home screen to be displayed.

7. MAINTENANCE ACTIVITIES

Disassembly a weighing pan and other detachable components (the components differ depending on a balance type – see: UNPACKING AND INSTALLATION section).

Caution:

Cleaning anti-draft chamber while still installed may cause damage of the measuring system.

7.1. Cleaning ABS Components

To clean dry surfaces and avoid smutching use clean non-colouring cloths made of cellulose or cotton. You can use a solution of water and detergent (soap, dishwashing detergent, glass cleaner). Gently rub the cleaned surface and let it dry. Repeat cleaning process if needed.

In the case when contamination is hard to remove, e.g. adhesive, rubber, resin, polyurethane foam residues etc., you can use a special cleaning agents based on a mixture of aliphatic hydrocarbons that do not dissolve plastics. Before using the cleanser for all surfaces we recommend carrying out tests. Do not use products containing abrasive substances.

7.2. Cleaning Stainless Steel Components

Avoid using cleansers containing any corrosive chemicals, e.g. bleach (containing chlorine). Do not use products containing abrasive substances. Always remove the dirt using microfiber cloth to avoid damage of protective coating.

In case of a daily maintenance:

1. Remove the dirt using cloth dipped in warm water.
2. For best results, add a little dishwashing detergent.

8. TEMPERATURE STABILIZATION

- For correct operation of the balance the temperature has to range $+15^{\circ}\text{C} \pm +30^{\circ}\text{C}$;
- On switching on, the balance requires 30 minutes of temperature stabilization time.
- During temperature stabilization displayed information may change.
- Adjustment has to be carried out after temperature stabilization.
- Any changes of temperature and humidity during operation can cause indications errors. Errors can be corrected by carrying out user adjustment.

9. KEYPAD

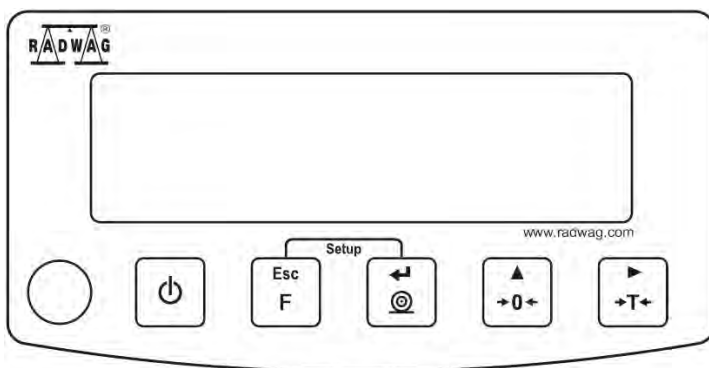







Fig. 5. WTC series keypad

10. KEYS

- | | |
|---|---|
|  | Press to switch the balance on/off |
|  | Function button: press to select respective operation mode. |
|  | Press to send the weighing result to a printer or a computer. |
|  | Press to zero the balance. |
|  | Press to tare the balance. |

Caution:

On pressing (Esc F) and (Balance menu icon) keys balance menu is displayed and keys' functions change. For detailed overview of keys' functions go further down this user manual.

11. PROGRAM

Main menu is divided into function groups. Function group is a group of interrelated parameters.

Parameter No.		Name	Options	Overview	
P1.		CAL		Adjustment	
	1.1.	CA-E	-	External adjustment	
	1.2.	CA-U	-	User adjustment with external weight	
P2.		rEAd	-	Balance parameters	
	2.1.	FIL	1, 2, 3	Filter	
	2.2.	APPPr	FASt, PrEc, F_P	Value release	
	2.3.	Enut	StAb, nStAb	Environment	
	2.4.	Aut	YES, no	Autozero	
	2.5.	tare	no, tArF, AtAr, EACh	Tare	
	2.6.	ttr	tArEH, tArnn	Tare implementing method	
	2.7.	LdiG	ALAS, nEur, uuSt	Last digit	
P3.		Func	-	Working modes	
	3.1.	UUGG	-	Weighing	
		3.1.1 .	Acc	YES, no	Working mode On/Off
		3.1.2 .	Snn	StAb, nStAb, rEPL	Save mode
		3.1.3 .	Lo	-	LO Threshold
	3.2.	PCS	-	Parts counting	
		3.2.1 .	Acc	YES, no	Working mode On/Off
		3.2.2 .	UUT	S_s, Suu	Working mode
		3.2.3 .	Snn	StAb, nStAb, rEPL	Save mode
		3.2.4 .	Lo	-	LO Threshold
	3.3.	HiLo	-	+/- control	
		3.3.1 .	Acc	YES, no	Working mode On/Off

		3.3.2 .	Snn	StAb, nStAb, rEPL	Save mode
		3.3.3 .	Lo	-	LO Threshold
	3.4.		dEu	-	Percent weighing

		3.4.1	Acc	YES, no	Working mode On/Off
		3.4.2	UUT	S_s, Suu	Working mode
		3.4.3	Snn	StAb, nStAb, rEPL	Save mode
		3.4.4	Lo	-	LO Threshold
	3.5.		toP	-	Peak hold
		3.5.1	Acc	YES, no	Working mode On/Off
		3.5.2	Lo	-	LO Threshold
	3.6.		Add	-	Totalizing
		3.6.1	Acc	YES, no	Working mode On/Off
		3.6.2	Snn	StAb, nStAb, rEPL	Save mode
		3.6.3	Lo	-	LO Threshold
P4.			Conn	-	Interfaces
	4.1.		rS	-	RS232 parameters settings
		4.1.1	bAd	2400, 4800, 9600, 19200, 38400, 57600, 115200	RS 232 baud rate
		4.1.2	PAr	nonE, Odd, EuEn	Parity
P5.			ducE	-	Peripherals
	5.1.		PC	-	Computer
		5.1.1	Prt	nonE, rS232, USbB	Computer port
		5.1.2	Cnt	nonE, CntA, Cntb	Continuous Transmission
		5.1.3	Int	0.1[s] - 1000[s]	Continuous transmission time interval
	5.2.		Prtr	-	Printer
		5.2.1	Prt	nonE, rS232, USbb	Printer port
P6.			Prnt		Printouts
	6.1.		CrEP	-	Adjustment report
		6.1.1	CtP	YES, no	Adjustment type
		6.1.2	dAt	YES, no	Date
		6.1.3	tin	YES, no	Time
		6.1.4	ldb	YES, no	Balance S/N
		6.1.5	CdF	YES, no	Adjustment difference





		6.1.6 .	dSh	YES, no	Dashes
		6.1.7 .	SiG	YES, no	Signature
	6.2.		GLP	-	GLP Printout
		6.2.1 .	dAt	YES, no	Date
		6.2.2 .	tin	YES, no	Time
		6.2.3 .	n	YES, no	Net
		6.2.4 .	t	YES, no	Tare



		6.2.5 .	b	YES, no	Gross
		6.2.6 .	CrS	YES, no	Current result
		6.2.7 .	CrP	YES, no	Adjustment report
P7.			Misc		Miscellaneous
	7.1.		bLbt	no, 10, 20, 30, 40, 50, 60, 70, 80, 90, 100	Backlit level in [%]
	7.2.		bEEP	YES, no	Key sound
	7.3.		t1	nonE, 1, 2, 3, 5, 10	Time-defined finish mode
	7.4.		SdAt	-	Date
	7.5.		Stnn	-	Time
	7.6.		FdAt	1, 2, 3, 4	Date format
	7.7.		Ftin	12H, 24H	Time format
	7.8.		dFLu	-	User default settings
P8.			InFo		Information on balance
	8.1.		ldb	-	Balance serial number
	8.2.		PurS	-	Program version
P9.			Unit	-	Units
	9.1.		UnSt	g, kg, N, ct, lb	Start unit
	9.2.		Unin	g, kg, N, ct, lb	Temporary unit valid until the balance is turned off.

12. OPERATING BALANCE MENU

Use keypad to navigate in menu.

12.1. Keypad

	Press to enter 'Main Menu'
	Press to manually enter tare Press to enter tare from tare values database Press to edit parameter value and to change it by 1 digit up Press to move the menu up
	Press to check battery status
	Press to preview date/time
	Press to move the menu down Press to change current parameter value

	Press to enter particular submenu Press to select parameter that is to be modified
	Press to confirm introduced modifications
	Press to leave, parameter remains unmodified Press to move one menu level up

12.2. Return to the Weighing Mode

Any changes made in balance's memory are automatically saved on return to the main window.  To return to the main window press key.

13. WEIGHING

Load the weighing pan. You can read weighing result when , pictogram is displayed. To assure long-term operation and correct mass measurements follow the rules presented below:

- Load the weighing pan steadily avoiding shocks:

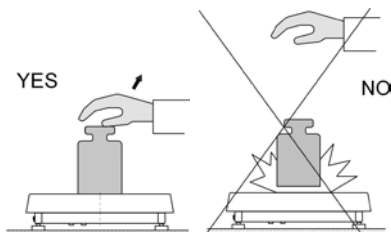

- Place weighed loads centrally on the weighing pan (eccentricity errors are specified by PN-EN 45501 standard, points 3.5 and 3.6.2.):

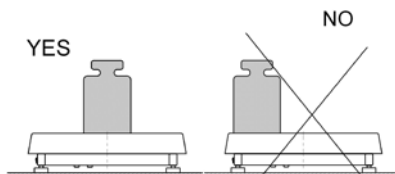

- Do not load the pan with concentrated force:

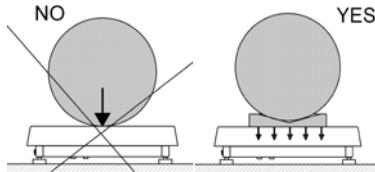

- Avoid side loading, in particular side shocks:

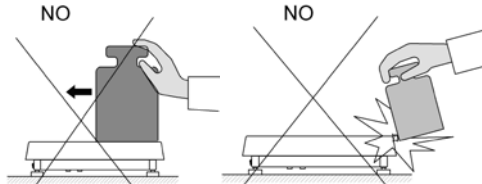

13.1. Taring

To determine net mass, put the packaging on the weighing pan. On stabilizing,

press  key (indication changes to zero, **Net** pictogram is displayed in the left upper corner):

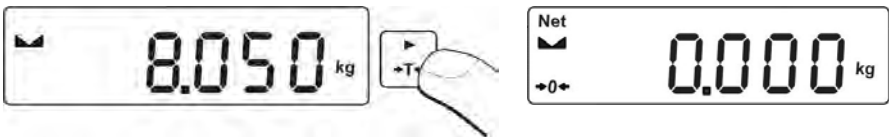

On loading the weighing pan net mass is displayed. You can tare repeatedly within the whole measuring range. While using tare function remember not to exceed the maximum measuring range of the balance. On unloading the weighing pan, the sum of tared masses with minus sign is displayed.

Caution:

*Taring cannot be performed when the displayed value is negative or equal zero. In such case message **Err3** is displayed and short signal is emitted.*

13.2. Manual Tare Entering

- Simultaneously press  and  keys.

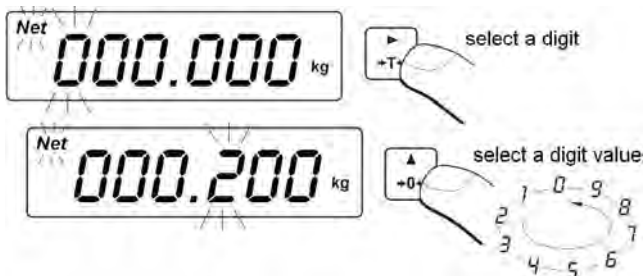

- Using and keys set **tare value**,
- Press key,
- Balance returns to weighing mode. Tare value with '-' sign is displayed.
- Tare can be entered at any moment during the weighing process.

Caution:

Tare cannot be entered manually when tare value is already implemented to balance's memory. In such case message <Err3> is displayed and a short signal is emitted.

13.3. Zeroing

To zero mass indication press key. Zero value and following pictograms and are displayed. It is possible to zero the balance only when the indication is stable.

Caution:

Indication can be zeroed only within $\pm 2\%$ range of maximum capacity. If the zeroed value is greater than $\pm 2\%$ of the maximum capacity, message <Err2> is displayed and short signal is emitted.

13.4. Weighing for Dual Range Balances

Switching from weighing with the accuracy of the **I weighing range** to weighing with the accuracy of the **II weighing range** takes place automatically on exceeding Max of **I weighing range**.

On switching to weighing with the accuracy of the **II weighing range**, symbol is displayed on the left.

On unloading the weighing pan indication zeroes. Weighing is carried out with **II range** accuracy until the indication is zeroed.

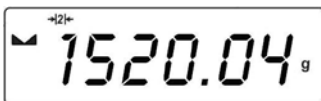

Switching from weighing with the accuracy of the **II weighing range** to weighing with the accuracy of the **I weighing range** takes place automatically on unloading the weighing pan and returning to AUTOZERO – (symbol $\rightarrow 0 \leftarrow$ is displayed). II weighing range pictogram is blanked and the balance switches back to the **I weighing range**.

13.5. Units

<P9.Unit> parameters group enables selecting start and temporary unit. Selecting unit other than [g] is possible during weighing or during other modes operation. 'Parts counting' and 'Percent weighing' modes are exceptions for which the unit cannot be changed.

13.5.1. Start Unit

Setting the start unit.

Procedure:

- Enter **<P9.Unit / 9.1.UnSt>** submenu.
- Press key to view available units:

Options:

- A. When [kg] is the main unit, then you can select the following units:[kg, lb, N]; *[lb] unavailable for verified balances,*
- B. When [g] is the main unit, then you can select the following units:[g, ct, lb]; *[lb] unavailable for verified balances,*

- On selecting start unit, press key to confirm. Next, press key to return to home screen.
- The balance turns on with start unit selected.

13.5.2. Temporary Unit

Temporary unit remains active until the balance is turned off.

Procedure:

- Enter **<P9.Unit / 9.2.Unin>** submenu.

- Press  key to view available units:

Options:



- When [kg] is the main unit, then you can select the following units:: [kg, lb, N]; [*lb*] *unavailable for verified balances*,
- When [g] is the main unit, then you can select the following units:[g, ct, lb]; [*lb*] *unavailable for verified balances*,

- On selecting start unit, press  key to confirm and return to home screen.

14. BALANCE PARAMETERS

You can adjust the balance to ambient conditions (filter level) or to your own needs (autozero, tare value). The parameters are to be found in **<P2.rEAd>** submenu.

14.1. Filter Level

- Enter **<P2.rEAd / 2.1.FiL>** submenu
- Press  key to view available filter values: **1** - fast, **2** - average, **3** – slow,
- Press  key to confirm. Return to home screen.

Caution:

The higher filter level, the longer the indication takes to stabilise.

14.2. Value Release

Parameter related with the stabilization rate of measurement result. Depending on the selected option, weighing time is either shorter or longer.

Procedure:

- Enter **<P2.rEAd / 2.2.APPr>** submenu.
- Press  key to view available options:

- F_P** - Fast and reliable
- PrEc** - Reliable
- FASt** - Fast





- Press  key to confirm. Return to home screen.

14.3. Balance Ambient Conditions

Parameter relating to ambient and environmental conditions in which the balance operates. If the ambient conditions are unstable (air drafts, vibrations), select 'unstable' option.

Procedure:



- Enter **<P2.rEAd / 2.3.Enut>** submenu.
- Press  key to view available options: **nStAb** – unstable, **StAb** – stable.
- Press  key to confirm. Return to home screen.

14.4. Autozero

The software features an autozero function (Auto) ensuring precise mass indication. This function automatically controls and corrects zero indication.

There are, however, some cases when this function can be a disturbing factor for the measuring process; e.g. very slow placing of a load on the weighing pan (load adding). In such case, it is recommended to disable the function.



Procedure:

- Enter **<P2.rEAd / 2.4.Aut>** submenu.
- Press  key to view available options: **YES** – function enabled, **no** – function disabled.
- Press  key to confirm. Return to home screen.

14.5. Tare

Function enables setting appropriate parameters related with taring.



Procedure:

- Enter **<P2.rEAd / 2.5.tArA>** submenu.
- Press  key to view available options:
 - no** - Basic tare mode. Set (selected) tare value is overwritten on entering new tare value.
 - tArF** - Last tare value is stored in balance's memory. Tare value is automatically displayed on restarting the balance.
 - AtAr** - Tare value is saved after the power supply is disconnected.
 - EAcH** - Automatic taring of each approved measurement.
- Press  key to confirm. Return to home screen.

14.6. Last Digit

Function enables displaying the last digit of decimal place for a weighing result - the measurement is carried out with lesser accuracy.

Procedure:

- Enter **<P2.rEAd / 2.6.LdiG>** submenu.
- Press  key to view available options:
 - ALAS** - All digits visible.
 - nEur** - Last digit is not displayed.
 - uuSt** - Last digit is displayed only for a stable weighing result.
- Press  key to confirm. Return to home screen.

15. ADJUSTMENT

option available for non-verified balances exclusively

In order to ensure the highest weighing accuracy, it is recommended to periodically introduce a corrective factor of indications to balance memory, the said factor must be referred to a reference mass. It is a balance adjustment.

Adjustment has to be carried out:

- prior weighing,
- if long breaks between following measuring series occur,
- if the ambient temperature has changed dynamically,
- if the balance's place of use has changed.

Types of adjustment:

- External adjustment **<1.1.CA-E>** carried out with external weight of declared mass which cannot be modified.
- User adjustment **<1.2.CA-u>** carried out with any external weight of mass equal or greater than 30% of maximum capacity.

15.1. External Adjustment

External adjustment is carried out using external weight of class F₁.

Procedure:

- Enter **<P1.CAL / 1.1.CA-E>** submenu. Message **<UnLoAd>** (unload the weighing pan) is displayed.



- On unloading the weighing pan, press  key.
- Balance starts determining mass of an empty weighing pan. The process is signalled by dashes **<- >**. Next, message **<Load>** (put weight) is displayed along with mass value to be put onto weighing pan; e.g.. **200.000g** (depending on balance type).



- Put the weight of a given mass and press  key.
- Balance starts determining mass of a weight. The process is signalled by dashes **<- >**. Next, message **<UnLoad>** (remove weight) is displayed.
- On unloading the weighing pan, submenu **<1.1.CA-E>** is displayed.

15.2. User Adjustment

User adjustment is carried out using external weight of class F₁.

Procedure:

- Enter **<P1.CAL / 1.2.CA-u>** submenu. Message box for entering mass of a weight used for user adjustment is displayed. Mass of the weight has to be equal or greater than 30% of maximum capacity.



- On entering and confirming the weight mass, message **<UnLoAd>** (unload the weighing pan) is displayed.



- On unloading the weighing pan, press  key.
- Balance starts determining mass of an empty weighing pan. The process is signalled by dashes **<- >**. Next, message **<Load>** (put weight) is displayed along with declared mass value to be put onto weighing pan; e.g., **100.000g**.



- Put the weight of a given mass and press  key.
- Balance starts determining mass of a weight. The process is signalled by dashes **<- >**. Next, message **<UnLoad>** (remove weight) is displayed.
- On unloading the weighing pan submenu **<1.2.CA-u>** is displayed.

15.3. Adjustment Report

Adjustment report is automatically printed on a printer connected to the balance at the end of each adjustment. Report content is to be declared in **<P6.1.CrEP>** menu and described further down this user manual.

16. INTERFACES



<P4.Conn> menu enables configuration of ports settings. The balance can communicate with a peripheral device, the communication is established via the following interfaces: RS232, USB type A, USB type B. USB type B port is used for connecting a computer. USB type A port is used for connecting a printer or a flash drive.

16.1. RS232 Settings



In **<P4.Conn>** menu, the following RS232 transmission parameters can be set:

- Baud rate,
- Parity.

16.1.1. Baud Rate

- Enter **<P4.Conn / 4.1.rS / 4.1.1.bAd>** submenu.
- Press  key to view available options: **2400, 4800, 9600, 19200, 38400, 57600, 115200**.
- Press  key to confirm. Return to home screen.

16.1.2. Parity

- Enter **<P4.Conn / 4.1.rS / 4.1.2.PAr>** submenu.
- Press  key to view available options: **nonE** – none; **EuEn** – even; **Odd** – odd.
- Press  key to confirm. Return to home screen.

17. PERIPHERALS



<P5.ducE> menu comprises list of devices that can cooperate with the balance.

17.1. Computer



In **<5.1.PC>** menu you can:

- Select interface to which a computer with program enabling computer-balance communication is connected.
- Enable or disable continuous transmission.
- Set time interval for printouts during continuous transmission.

17.1.1. Computer Port

- Enter **<5.1.PC / 5.1.1.Prt>** submenu.
- Press  key to view available options: **nonE** – none; **rS232** – RS232, **USbB** – USB type B.
- Press  key to confirm. Return to home screen.

17.1.2. Continuous Transmission

- Enter **<5.1.PC / 5.1.2.Cnt>** submenu.
- Press  key to view available options:
 - nonE** - Continuous transmission disabled
 - CntA** - Continuous transmission in basic unit.
 - Cntb** - Continuous transmission in current unit.
- Press  key to confirm. Return to home screen.

17.1.3. Interval For Printouts During Continuous Transmission

Interval for printouts is set in seconds with 0.1[s] accuracy. You can set any interval value ranging from 0.1 to 3600 seconds.



Procedure:

- Enter **<5.1.PC / 5.1.3.Int>** submenu. Message box for entering interval value is displayed.
- Press  key to confirm. Return to home screen.

17.2. Printer

<5.2.Prtr> menu enables selecting port to which data is send on pressing  key. Content of sent data is set in **<P6.Prnt>** submenu and described further down this user manual.

17.2.1. Printer Port

- Enter **<5.2.Prtr / 5.2.1.Prt>** submenu.
- Press  key to view available options:
 - nonE** - None
 - rS232** - RS232 port
 - USbB** - USB type B port for connecting a computer.
- Press  key to confirm. Return to home screen.

18. PRINTOUTS

<P6.Prnt> menu enables defining printout templates of:

- Adjustment report
- GLP printout

18.1. Adjustment Report Printout

<6.1.CrEP> menu enables declaring data that is to be printed on adjustment printout.

List of data to be declared:

No.	Name	Overview
6.1.1.	CtP	Adjustment type
6.1.2.	dAt	Adjustment date
6.1.3.	tin	Adjustment time
6.1.4.	ldb	Balance serial number
6.1.5.	CdF	Difference between mass of adjustment weight that was measured during last adjustment and mass of currently measured adjustment weight.
6.1.6.	dSh	Line separating data and signature fields on a printout.
6.1.7.	SiG	An area for the signature of a user performing the adjustment.

For the parameters described above, one of these values must be selected:

- YES** - Print
- no** - Do not print

Caution:

Printouts are printed in English

Exemplary report:

```
-----Calibration Report-----
Calibration type           External
Date                       2016.10.15
Time                       12:39:23
Balance ID                 123456
Difference                  -0.02g
-----
Signature
.....
```

18.2. GLP Printout

<6.2.GLP> menu enables declaring data that is to be printed on a **GLP** printout.

List of data to be declared:

No.	Name	Overview
6.2.1.	dAt	Performed weighing date.
6.2.2.	tin	Performed weighing time.
6.2.3.	n	Net weight value of performed weighing in basic unit.
6.2.4.	t	Tare weight value of performed weighing in current unit.
6.2.5.	b	Gross weight value of performed weighing in current unit.
6.2.6.	CrS	Current result (net weight value) in a current unit.
6.2.7.	CrP	Last adjustment report in accordance with adjustment report printout settings.

For the parameters described above, one of these values must be selected:

YES - Print

no - Do not print

Caution:

Printouts are printed in English

Exemplary report:

Date	2016.10.15
Time	12:04:17
Net	49.98g
Tare	17.20g
Gross	67.18g

19. MISCELLANEOUS



<P7.Misc> menu allows to customize the balance by setting:

- Display brightness
- 'Beep' sound - reaction to pressing a key
- Time-defined finish mode
- Date and time
- Date and time format

19.1. Backlight

<7.1.bLbt> parameter enables setting display brightness. The backlight can be disabled completely.



Procedure:

- Enter **<P7.Misc / 7.1.bLbt>** submenu.
- Press  key to view available options, where:
 - 100** - Maximum brightness
 - 10** - Minimum brightness
 - nonE** - Backlight disabled.
- Press  key to confirm. Return to home screen.

19.2. 'Beep' Sound

<7.2.bEEP> parameter enables switching on/off a 'beep' sound responsible for informing a user about pressing any key.

Procedure:

- Enter **<P7.Misc / 7.2.bEEP>** submenu.
- Press  key to view available options:
 - no** - disabled
 - YES** - enabled
- Press  key to confirm. Return to home screen.

19.3. Automatic Shutdown

<7.3.t1> parameter enables automatic shutdown of the balance.

Procedure:

- Enter **<P7.Misc / 7.3.t1>** submenu.
- Press  key to view available options:

- nonE** - Automatic shutdown disabled.
- 1, 2, 3, 5, 10** - Time in [min]. If the indication is stable during declared time, the balance is shutdown automatically.



- Press  key to confirm. Return to home screen.

19.4. Date

<7.4.SdAt> parameter enables setting current date.

Procedure:

- Enter **<P7.Misc / 7.4.dAt>** submenu. Message box is displayed:

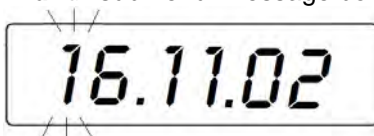

Where:

- 16** - Year
- 11** - Month
- 02** - Day



- Press  key to confirm. Return to home screen.

19.5. Time

<7.5.Stnn> parameter enables setting current time.

Procedure:

- Enter **<P7.Misc / 7.5.dAt>** submenu. Message box is displayed:



Where:



- 12** - Hour
- 05** - Minute

- Press  key to confirm. Return to home screen.

19.6. Date Format

<7.6.FdAt> parameter enables defining date format for printouts.



Procedure:

- Enter <P7.Misc / 7.6.FdAt> submenu.
- Press  key to view available options:
 - 1 - Date format DD.MM.YYYY
 - 2 - Date format MM.DD.YYYY
 - 3 - Date format YYYY.MM.DD
 - 4 - Date format YYYY.DD.MM
- Press  key to confirm. Return to home screen.

19.7. Time Format

<7.7.Ftin> parameter enables defining time format for printouts.

Procedure:

- Enter <P7.Misc / 7.7.Ftin> submenu.
- Press  key to view available options:
 - 24 H - 24 hour time format
 - 12 H - 12 hour time format
- Press  key to confirm. Return to home screen.

19.8. User Menu Default Settings

<P7.8.dFLu> parameter enables setting user default settings.

Procedure:

- Enter <P7.Misc / 7.8.dFLu> submenu.
- Message <Cont?> (continue?) is displayed.



- Press  key to confirm. Balance restores user default settings. The process is signalled by dashes <- >.
- On process completion, balance displays <7.8.dFLu> submenu.

20. INFORMATION

<P8.InFo> menu comprises information on the balance.

- Balance serial number – <8.1.Idb> parameter
- Program version – <8.2.PurS> parameter.



Parameters serve information purpose only.

21. WORKING MODES

The balance features the following working modes:

- Weighing,
- Parts counting,
- +/- control,
- Percent weighing,
- Peak hold,
- Totalising.

21.1. Running Working Mode

- In home screen press  key. Name of first available working mode is displayed.
- Press  key to view available working modes.
- Press  key to enter a working mode.

Caution:

The balance is restarted with the last working mode activated.

21.2. Working Modes Settings

Particular working modes settings feature specific functions. The functions enable adapting mode operation to your individual needs. The special settings are to be activated in <P3.Func> submenu.



21.3. Weighing

<UUGG> (Weighing) mode is a standard working mode that enables carrying out weighings and saving them to the database.

21.3.1. Working Mode Accessibility

Press  to enable or disable a working mode.

Procedure:



- Enter <3.1.UUGG / 3.1.1.Acc> submenu.
- Press  key to view available options: **YES** – working mode enabled, **no** – working mode disabled.
- Press  key to confirm. Return to home screen.

21.3.2. Save Mode

In accordance with <3.1.2.Snn> parameter's setting, you can declare method of sending the information from the balance to a peripheral device (printer, computer).

Procedure:

- Enter <3.1.UUGG / 3.1.2.Snn> submenu.
- Press  key to view available options:

StAb	Manual printout of stable weighing result and <6.2.GLP> parameter's settings. While pressing  key when the result is unstable (no  pictogram displayed), the result is to be printed on measurement stabilization.
nStAb	Manual printout of each weighing result and <6.2.GLP> parameter's settings. In case when the result is unstable, <?> sign is displayed at the beginning of mass frame. Function available for non-verified balances exclusively.
rEPL	Automatic printout of the first stable weighing result above <Lo> threshold.

- Press  key to confirm. Return to home screen.

21.3.3. LO Threshold

<3.1.3.Lo> parameter is connected with automatic operation. Next measurement is saved when mass indication is below <Lo> **threshold** value.

Procedure:

- Enter <3.1.UUGG / 3.1.3.Lo> submenu. Message box for entering <Lo> **threshold** value is displayed.

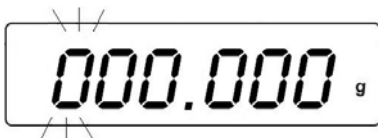

- Press  key to confirm. Return to home screen.

21.4. Parts Counting

Standard balance features parts counting option. Parts of the same mass are counted based on determined and reference mass of a single part.

21.4.1. Working Mode Accessibility

<3.2.1.Acc> 'Working mode accessibility' parameter's settings are identical with <3.1.1.Acc> parameter's settings for 'Weighing' mode. They are described in 'Weighing' section of this user manual.

21.4.2. Selecting Working Mode

You can select way of determining reference mass of a single part.

Procedure:

- Enter <3.2.PcS / 3.2.2.UUt> submenu.

- Press  key to view available options:

- S_s** - Setting reference mass by determining mass of a single part.
- Suu** - Setting reference mass by entering mass of a single part.

- Press  key to confirm. Return to home screen.

21.4.3. Save Mode

<3.2.3.Snn> 'Save mode' parameter's settings are identical with <3.1.2.Snn> parameter's settings for 'Weighing' mode. They are described in 'Weighing' section of this user manual.

21.4.4. LO Threshold

<3.2.4.Lo> 'Lo threshold' parameter's settings are identical with <3.1.3.Lo> parameter's settings for 'Weighing' mode. They are described in 'Weighing' section of this user manual.

21.4.5. Setting Reference Mass by Entering Mass of a Single Part

- In accordance with point 21.4.2. of this user manual set working mode to <Suu> parameter.
- Enter 'Parts counting' <PcS> working mode.
- Message <SEt_Ut> is displayed for 1 s. Next, a message box for entering value of a single part's mass is displayed.



- Press  key to confirm. Home screen is displayed automatically with quantity of parts on the weighing pan displayed.

Caution:

If entered mass of a single part is greater than maximum capacity, message <Err Hi> is displayed.

21.4.6. Setting Reference Mass by Determining Mass of a Single Part

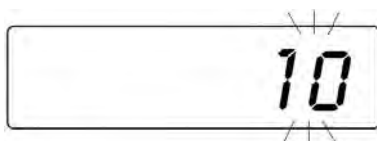

- In accordance with point 21.4.2. of this user manual, set working mode to <S_S> parameter.
- Enter 'Parts counting' <PcS> working mode.
- Blinking quantity of parts is displayed.



- Press  key and select an option:
 - 10** - Reference quantity:10 parts.
 - 20** - Reference quantity:20 parts.
 - 50** - Reference quantity:50 parts.
 - 100** - Reference quantity:100 parts.
 - 000** - Any reference quantity: - enter a value.
 - 0**

- Press  key to confirm. Message **<LoAd>** is displayed for 1 s. Next, the following window is displayed:



- If the parts are to be weighed in a container, first put it on a weighing pan and next tare it.
- Load the weighing pan with declared amount of parts. When the indication is stable ( pictogram is displayed) press  key to confirm the mass.
- Mass of a single part is automatically measured and displayed:



Remember:

- Maximum mass of all parts on the weighing pan cannot be greater than maximum capacity.*
- Mass of a single part has to be equal or greater than **0.1 reading unit** of the balance. If the abovementioned condition is not fulfilled, message **<Err Lo>** is displayed.*
- During parts counting determination wait until  pictogram is displayed. Next, confirm declared quantity of parts.*

21.5. +/- Control

+/- control working mode enables entering checkweighing thresholds values (**Min, Max**).

21.5.1. Working Mode Accessibility

<3.3.1.Acc> 'Working mode accessibility' parameter's settings are identical with <3.1.1.Acc> parameter's settings for 'Weighing' mode. They are described in 'Weighing' section of this user manual.

21.5.2. Save Mode

<3.3.2.Snn> 'Save mode' parameter's settings are identical with <3.1.2.Snn> parameter's settings for 'Weighing' mode. They are described in 'Weighing' section of this user manual.

21.5.3. LO Threshold

<3.3.3.Lo> 'Lo threshold' parameter's settings are identical with <3.1.3.Lo> parameter's settings for 'Weighing' mode. They are described in 'Weighing' section of this user manual.

21.5.4. Declaring Checkweighing Thresholds

- Enter „+/- control” <HiLo> working mode. Message <SEt Lo> is displayed for 1s. Next, a message box for entering low threshold (Min) value is displayed.



- Enter the value and press  key to confirm. Message <SEt Hi> is displayed for 1 s. Next, a message box for declaring high threshold (Max) is displayed.



- Enter the value and press  key to confirm. Working mode home screen is displayed. Threshold value is displayed in the upper part of the display.

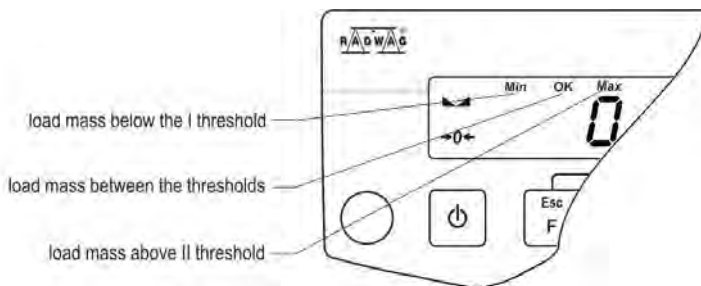

Caution:

<Err Lo> message is displayed:

1. If value of entered low threshold (Min) is greater than high threshold value (Max).
2. If value of entered low threshold (Min) is greater than maximum capacity.

21.6. Percent Weighing Against Reference Sample Mass

Working mode enables comparison of a measured sample with the reference mass. The result is expressed in [%]. Reference mass can be determined by weighing or entered to balance's memory.



21.6.1. Working Mode Accessibility

<3.4.1.Acc> 'Working mode accessibility' parameter's settings are identical with <3.1.1.Acc> parameter's settings for 'Weighing' mode. They are described in 'Weighing' section of this user manual.

21.6.2. Selecting Working Mode

You can select way of determining reference mass.

Procedure:

- Enter <3.4.dEu / 3.4.2.UUt> submenu.
- Press  key to view available options:
 - S_S** - Setting reference mass by determining mass
 - Suu** - Setting reference mass by entering known mass.
- Press  key to confirm. Return to home screen.

21.6.3. Save Mode

<3.4.3.Snn> 'Save mode' parameter's settings are identical with <3.1.2.Snn> parameter's settings for 'Weighing' mode. They are described in 'Weighing' section of this user manual.

21.6.4. LO Threshold

<3.4.4.Lo> 'Lo threshold' parameter's settings are identical with <3.1.3.Lo> parameter's settings for 'Weighing' mode. They are described in 'Weighing' section of this user manual.

21.6.5. Reference Mass Determined by Weighing

- In accordance with point 21.6.2. of this user manual, set working mode to <S_S> parameter.
- Enter 'Percent Weighing'<dEu> mode.
- Message <Load> is displayed for 1s. Next, the following window is displayed:



- Load the weighing pan with reference mass. When the indication is stable (📏 pictogram is displayed) press  key to confirm the mass.
- Value of weighed load is automatically entered as reference mass. Next, home screen with **100.000%** value is displayed.

21.6.6. Reference Mass Determined by Entering

- In accordance with point 21.6.2. of this user manual, set working mode to <Suu> parameter.
- Enter 'Percent Weighing'<dEu> mode.
- Message <SEt_Ut> is displayed for 1s. Next, a message box for entering mass value is displayed.

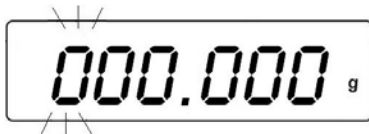

- Press  key to confirm. Home screen with **0.000%** value is displayed.

Caution:

If entered reference mass value is greater than maximum capacity, message **<Err Hi>** is displayed.

21.7. Peak Hold

<toP> function enables snapping value of maximum force applied to the weighing pan during one loading.

21.7.1. Working Mode Accessibility

<3.5.1.Acc> 'Working mode accessibility' parameter's settings are identical with **<3.1.1.Acc>** parameter's settings for 'Weighing' mode. They are described in 'Weighing' section of this user manual.

21.7.2. LO Threshold

<3.5.2.Lo> 'Lo threshold' parameter's settings are identical with **<3.1.3.Lo>** parameter's settings for 'Weighing' mode. They are described in 'Weighing' section of this user manual.

21.7.3. Means of Operation

- In accordance with point 21.3.3. of this user manual, set 'Lo threshold' **<Lo>** parameter's value. Determine the point beyond which the function starts to register maximum force applied.
- Enter 'Peak hold' **<toP>** mode.
- From now on the balance registers and holds every single weightment which is above the **<Lo>** threshold, and which is higher than the result of the previous peak hold. If the software detects mass above the threshold, the highest detected indication is held on the main display and the pictogram **<Max>** is shown on the right, over the measuring unit.



- The start of the next process of peak hold measurement is possible only after removing the load from the weighing pan and pressing  key. This causes returning to the home screen of **<toP>** mode. Pictogram **<Max>** is automatically deleted.

21.8. Totalizing

Working mode enables mass totalizing of weighed ingredients and printing totalizing report on a printer connected to the balance. It is possible to totalize max. 30 weighings (ingredients) in one process.

21.8.1. Working Mode Accessibility

<3.6.1.Acc> 'Working mode accessibility' parameter's settings are identical with <3.1.1.Acc> parameter's settings for 'Weighing' mode. They are described in 'Weighing' section of this user manual.

21.8.2. Save Mode

<3.6.2.Snn> 'Save mode' parameter's settings are identical with <3.1.2.Snn> parameter's settings for 'Weighing' mode. They are described in 'Weighing' section of this user manual.

21.8.3. LO Threshold



<3.6.3.Lo> 'Lo threshold' parameter's settings are identical with <3.1.3.Lo> parameter's settings for 'Weighing' mode. They are described in 'Weighing' section of this user manual.

21.8.4. Totalizing Procedure

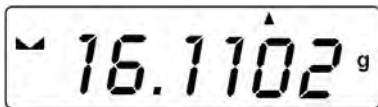
- Enter 'Totalizing'<Add> mode. A blinking '▲' pictogram is displayed in the upper part of the display.
- If the ingredients are to be weighed in a container, first put it on a weighing pan and next tare it.
- Load the weighing pan with first ingredient. When the indication is stable (▲ pictogram is displayed) press  key to confirm its mass.
- Weighings sum and '▲' pictogram are displayed continuously.





- Unload the weighing pan. ZERO indication is displayed and pictogram „▲” starts to blink.

- Load the weighing pan with another ingredient. On indication stabilization press  key.
- Sum of first and second weighings and „▲” pictogram are displayed continuously.
- Press  key to finish the process (with loaded or unloaded weighing pan). Message „Print?” <Prnt?> is displayed.
- Press  key. Sum of all saved weighings is printed on a printer connected to the balance.

Exemplary report:

(1)	13.500 g
(2)	14.400 g
(3)	9.700 g
(4)	100.500 g
(5)	4.000 g
(6)	8.200 g
(7)	20.800 g
(8)	5.800 g

Total:	176.900 g

- Press  key to print the report again. Press  key to exit.
- This causes returning to home screen of <Add> mode and automatic zeroing of data on carried out measurements.

Caution:

In case of exceeding display range of totalized mass on balance's display, message <Hi> is displayed. Remove the ingredient from the weighing pan and finish the process. Load the weighing pan with smaller mass that does not exceed display range of totalized mass.

22. DIAGRAMS OF CONNECTION CABLES

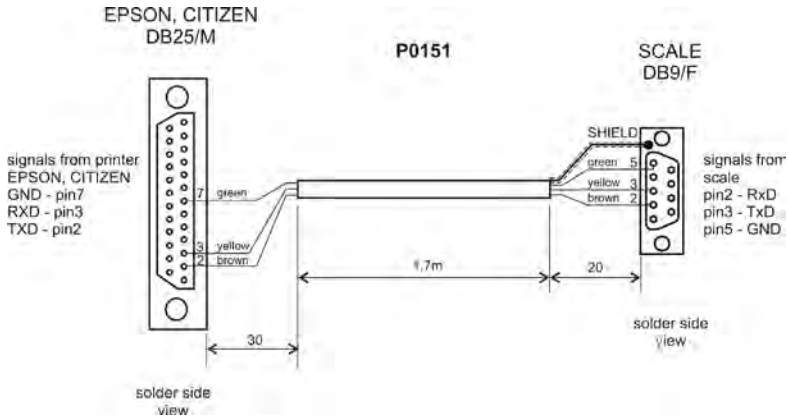

Balance - EPSON printer cable

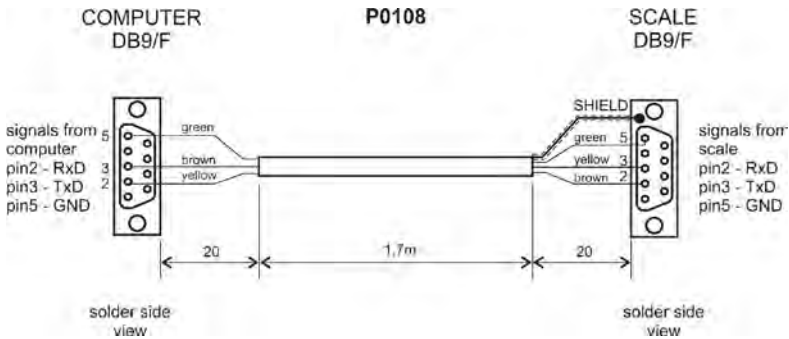

Balance - computer cable

23. COMMUNICATION PROTOCOL

23.1. General Information

- A character based communication protocol balance-terminal is designed for establishing communication between a RADWAG balance and a peripheral device via RS-232C interface.
- The protocol consists of commands sent from a peripheral device to the balance and responses from the balance.
- Responses are sent from the balance each time a command is received.

D. Commands, forming the communication protocol, enable obtaining data on balance status and facilitate influencing balance operation, e.g.: acquiring measurement results from the balance, monitoring the display, etc.

23.2. List of Commands

Command	Command overview
Z	Zero balance
T	Tare balance
OT	Give tare value
UT	Set tare
S	Send stable measurement result in basic measuring unit
SI	Immediately send measurement result in basic measuring unit
SU	Send stable measurement result in current measuring unit
SUI	Immediately send measurement result in current measuring unit
C1	Switch on continuous transmission in basic measuring unit
C0	Switch off continuous transmission in basic measuring unit
CU1	Switch on continuous transmission in current measuring unit
CU0	Switch off continuous transmission in current measuring unit
K1	Lock balance keypad
K0	Unlock balance keypad
NB	Give balance serial number
PC	Send all implemented commands

Caution:

1. Each command must end with CR LF characters;
2. Wait before sending another command until the former answer has been received, otherwise the answers may be lost.

23.3. Response Format

On receipt of a command, the indicator responds as follows:

XX_A CR LF	command understood and in progress
XX_D CR LF	command carried out (appears only after the XX_A command)
XX_I CR LF	command understood but not accessible at this moment
XX_ ^ CR LF	command understood but max threshold is exceeded
XX_ v CR LF	command understood but min threshold is exceeded
ES_CR LF	command not recognised
XX_ E CR LF	time limit exceeded while waiting for stable measurement result (time limit is a characteristic balance parameter)

XX - name of a sent command
 _ - space

23.4. Commands Overview

23.4.1. Zeroing

Format: **Z CR LF**

Response options:

Z_A CR LF	command understood and in progress
Z_D CR LF	command carried out
Z_A CR LF	command understood and in progress
Z_ ^ CR LF	command understood but zeroing range is exceeded
Z_A CR LF	command understood and in progress
Z_E CR LF	time limit exceeded while waiting for stable measurement result
Z_I CR LF	command understood but not accessible at this moment

23.4.2. Taring

Format: **T CR LF**

Response options:

T_A CR LF	command understood and in progress
T_D CR LF	command carried out
T_A CR LF	command understood and in progress
T_ v CR LF	command understood but taring range is exceeded
T_A CR LF	command understood and in progress
T_E CR LF	time limit exceeded while waiting for stable measurement result
T_I CR LF	command understood but not accessible at this moment

23.4.3. Give tare value

Format: **OT CR LF**

Response: **OT_TARA CR LF** - command carried out

Response format:

1	2	3	4	5-6	7-15	16	17	18	19	20	21
T	T	space	stability marker	space	tare	space	unit			CR	LF

Tare - 9 characters, right justification

Unit - 3 characters, left justification

23.4.4. Set tare

Format: **UT_TARA CR LF**, where **TARA** - tare value

Response options:

UT_OK CR LF	command carried out
UT_I CR LF	command understood but not accessible at this moment
ES CR LF	command not recognised (tare format incorrect)

Caution:

Use dot in tare format as decimal point.

23.4.5. Send stable measurement result in basic measuring unit

Format: **S CR LF**

Response options:

S_A CR LF	command understood and in progress
S_E CR LF	time limit exceeded while waiting for stable measurement result
S_I CR LF	command understood but not accessible at this moment
S_A CR LF MASS FRAME	command understood and in progress response: mass value in basic measuring unit

Response format:

1	2-3	4	5	6	7-15	16	17	18	19	20	21
S	space	stability marker	space	character	mass	space	unit			CR	LF

Example:

S CR LF – command sent from a computer

S _ A CR LF – command understood and in progress

S _ _ _ _ - _ _ _ _ _ 8 . 5 _ g _ _ CR LF - command carried out,
response: mass value in basic measuring unit.

23.4.6. Immediately send measurement result in basic measuring unit

Format: **SI CR LF**

Response options:

SI_I CR LF	command understood but not accessible at this moment
MASS FRAME	immediate response: mass value in basic measuring unit

Response format:

1	2	3	4	5	6	7-15	16	17	18	19	20	21
S	I	space	stability marker	space	character	mass	space	unit			CR	LF

Example:

SI CR LF – command sent from a computer

SI _ ? _ _ _ _ _ 1 8 . 5 _ k g _ CR LF - command carried out,
immediate response: mass value in basic measuring unit

23.4.7. Send stable measurement result in current measuring unit

Format: **SU CR LF**

Response options:

SU_A CR LF	command understood and in progress
SU_E CR LF	time limit exceeded while waiting for stable measurement result
SU_I CR LF	command understood but not accessible at this moment
SU_A CR LF MASS FRAME	command understood and in progress response: mass value in current measuring unit

Response format:

1	2	3	4	5	6	7-15	16	17	18	19	20	21
S	U	space	stability marker	space	character	mass	space	unit			CR	LF

Example:

S U CR LF – command sent from a computer

S U _ A CR LF - command understood and in progress

S U _ _ _ - _ _ 1 7 2 . 1 3 5 _ N _ _ CR LF - command carried out, response: mass value in current measuring unit.

23.4.8. Immediately send measurement result in current measuring unit

Format: **SUI CR LF**

Response options:

SUI_I CR LF	command understood but not accessible at this moment
MASS FRAME	immediate response: mass value in current measuring unit

Response format:

1	2	3	4	5	6	7-15	16	17	18	19	20	21
S	U	I	stability marker	space	character	mass	space	unit			CR	LF

Example:

S U I CR LF – command sent from a computer

S U I ? _ - _ _ _ 5 8 . 2 3 7 _ k g _ CR LF - command carried out, immediate response: mass value in current measuring unit

23.4.9. Switch on continuous transmission in basic measuring unit

Format: **C1 CR LF**

Response options:

C1_I CR LF	command understood but not accessible at this moment
C1_A CR LF MASS FRAME	command understood and in progress response: mass value in basic measuring unit

Response format:

1	2	3	4	5	6	7-15	16	17	18	19	20	21
S	I	space	stability marker	space	stability	mass	space	unit			CR	LF

23.4.10. Switch off continuous transmission in basic measuring unit

Format: **C0 CR LF**

Response options:

C0_I CR LF	command understood but not accessible at this moment
C0_A CR LF	command understood and carried out

23.4.11. Switch on continuous transmission in current measuring unit

Format: **CU1 CR LF**

Response options:

CU1_I CR LF	command understood but not accessible at this moment
CU1_A CR LF MASS FRAME	command understood and in progress response: mass value in current measuring unit

Response format:

1	2	3	4	5	6	7-15	16	17	18	19	20	21
S	U	I	stability marker	space	character	mass	space	unit			CR	LF

23.4.12. Switch off continuous transmission in current measuring unit

Format: **CU0 CR LF**

Response options:

CU0_I CR LF	command understood but not accessible at this moment
CU0_A CR LF	command understood and carried out

23.4.13. Lock balance keypad

Format: **K1 CR LF**

Response options:

K1_I CR LF	command understood but not accessible at this moment
K1_OK CR LF	command carried out

Caution:

Command is not saved on balance restart.

23.4.14. Unlock balance keypad

Format: **K0 CR LF**

Response: **K0_OK CR LF** - command carried out

23.4.15. Give balance serial number

Format: **NB CR LF**

Response options:

NB_A "Nr fabryczny" CR LF	command understood, response: serial number
NB_I CR LF	command understood but not accessible at this moment

"nr fabryczny" – serial number of the device. Inserted in between inverted commas.

Example:

NB CR LF – command sent from a computer

NB_A "123456" CR LF – balance serial number - 123456

23.4.16. Send all implemented commands

Format: **PC CR LF**

Response: **PC_- > Z,T,OT,UT,S,SI,SU,SUI,C1,C0,CU1,CU0,K1,K0,NB,PC**
- command carried out, all implemented commands have been sent.

23.5. Manual Printout / Automatic Printout

It is possible to generate printouts either manually or automatically.

- Manual printout is generated for stable weighing result. Load the platform, wait for a stable result and press  key.
- Automatic printout is generated for stable weighing result. Load the platform, wait for a stable result. No button needs to be pressed.

Caution:

For verified balance option of temporary weighing results printout is disabled.

Format:

1	2	3	4 -12	13	14	15	16	17	18
stability marker	space	character	mass	space	unit			CR	LF

Stability marker [space] if measurement result stable
 [?] if measurement result unstable
 [^] if high limit is out of range
 [v] if low limit is out of range

Character [space] for positive values
 [-] for negative values

Mass 9 characters with decimal point, right justification

Unit 3 characters, left justification

Command 3 characters, left justification

Example 1:

__ __ __ __ **1 8 3 2 . 0 _ g _ _ CR LF** - printout generated upon pressing ENTER/PRINT key.

Example 2:

? _ - _ _ _ _ **2 . 2 3 7 _ l b _ CR LF** - printout generated upon pressing ENTER/PRINT key.

Example 3:

^ _ _ _ _ _ **0 . 0 0 0 _ k g _ CR LF** - printout generated upon pressing ENTER/PRINT key.

23.6. Continuous Transmission

For continuous transmission mode the balance provides option of mass measurement printout in basic unit and in additional unit. The mode can be activated with command sent via interface, or by setting respective parameter values.

Format of frame sent when **<5.1.2.Cnt>** parameter is set to **CntA** value:

1	2	3	4	5	6	7-15	16	17	18	19	20	21
S	I	space	stability marker	space	character	mass	space	unit			CR	LF

- Stability marker** [space] if measurement result stable
 [?] if measurement result unstable
 [^] if high limit is out of range
 [v] if low limit is out of range
- Character** [space] for positive values
 [-] for negative values
- Mass** 9 characters with decimal point, right justification
- Unit** 3 characters, left justification
- Command** 3 characters, left justification

Format valid for **<5.1.2.Cnt>** parameter set to **Cntb** value:

1	2	3	4	5	6	7-15	16	17	18	19	20	21
S	U	I	stability marker	space	character	mass	space	unit			CR	LF

- Stability marker** [space] if measurement result stable
 [?] if measurement result unstable
 [^] if high limit is out of range
 [v] if low limit is out of range
- Character** [space] for positive values
 [-] for negative values
- Mass** 9 characters with decimal point, right justification
- Unit** 3 characters, left justification
- Command** 3 characters, left justification

24. TECHNICAL SPECIFICATIONS

	WTC 200	WTC 600.1	WTC 2000	WTC 3000
Maximum capacity	200g	600g	2000g	3100g
Readability [d]	0.001g	0.01g	0.01g	0.1g
Tare range	-200g	-600g	-2000g	-3100g
Repeatability*	0.002g	0.01g	0.01g	0.1g
Linearity	±0.004g	±0.02g	±0.03g	±0.3g
Stabilization time	2s	2s	2s	2s
Adjustment	External	External	External	External
Display	LCD (with backlight)	LCD (with backlight)	LCD (with backlight)	LCD (with backlight)
IP rating	IP 43	IP 43	IP 43	IP 43
RS 232	1	1	1	1
Power supply	100 ÷ 240 V AC 50 ÷ 60 Hz / 12 V DC + battery	100 ÷ 240 V AC 50 ÷ 60 Hz / 12 V DC + battery	100 ÷ 240 V AC 50 ÷ 60 Hz / 12 V DC + battery	100 ÷ 240 V AC 50 ÷ 60 Hz / 12 V DC + battery
Battery operating time (average time)	33h	33h	33h	33h
Operating temperature	+15 - +30 °C	+15 - +30 °C	+15 - +30 °C	+15 - +30 °C
Weighing pan dimensions	Ø100mm	128x128mm	128x128mm	128x128mm
Packaging dimensions [mm]	330x230x140	330x230x140	330x220x140	330x220x140
Interface	USB type A, USB type B, RS 232	USB type A, USB type B, RS 232	USB type A, USB type B, RS 232	USB type A, USB type B, RS 232
Mass	1.2/1.7kg	1.3/2kg	1.3/2kg	1.3/2kg

*) - Standard deviation

25. TROUBLESHOOTING

Problem	Cause	Solution
The balance does not switch on	Battery (batteries) discharged,	Connect it to the mains, charge the battery (batteries)
	No batteries (batteries not installed or installed incorrectly)	Check if batteries are installed correctly (polarization)
The balance switches off automatically	't1' parameter set to 'YES' value (the balance switches off automatically)	In 'Misc' menu change <7.3.t1> parameter setting to 'nonE' value.
During switching on, message 'LH' is displayed	Weighing pan loaded during switching on	Unload the weighing pan. Zero indication is displayed.

26. ERROR MESSAGES

- Err 2 -	- Value beyond zero range.
- Err 3 -	- Value beyond tare range.
- Err 4 -	- Adjustment weight or start mass out of range ($\pm 1\%$ for adjustment weight, ± 10 for start mass).
- Err Lo -	- Determined mass of single part in 'Parts counting' mode too small - Value of 'Min' threshold is greater than value of 'Max' threshold in '+/- control' mode.
- Err Hi -	- Entered value of single part greater than maximum capacity in 'Parts counting' working mode - Entered value of 'Max' threshold greater than maximum capacity in '+/- control' mode. - Entered reference mass greater than maximum capacity in '+/- control' mode.
- Err 8 -	- Time of the following operations exceeded: tarring, zeroing, start mass determining, adjustment process
- null -	- Zero value from converter.
- FULL -	- Weighing range exceeded.
- LH -	- Start mass error, indication out of range ($-5\% - +15\%$ of start mass).
- Hi -	- Display range of totalized mass on balance display exceeded in 'Totalizing' mode

27. ADDITIONAL EQUIPMENT

Accessories:

- **P0108** - computer cable.
- **P0151** - EPSON printer cable.
- **K0047** - 12V DC cigarette lighter cable.
- **EPSON** - thermal printer.
- **EPSON** - dot matrix printer.
- **AP2-1** - Power loop output.
- **KR-01** - RS232/RS485 converter.
- **KR-04-1** - RS232/Ethernet converter.
- **SAL/STONE/H** - anti-vibration stainless table.
- **SAL/STONE/C** - anti-vibration painted table.
- Mass standards with accessories.

Computer software:

- RAD-KEY.
- PW-WIN.



RADWAG WAGI ELEKTRONICZNE
ZAAWANSOWANE TECHNOLOGIE WAGOWE

